

WEB: [WWW.BLACK-LINE.COM.AU](http://WWW.BLACK-LINE.COM.AU)  
EMAIL: [INFO@BLACK-LINE.COM.AU](mailto:INFO@BLACK-LINE.COM.AU)  
CALL: 03 9357 8780

# BLACKLINE

AUSTRALASIA

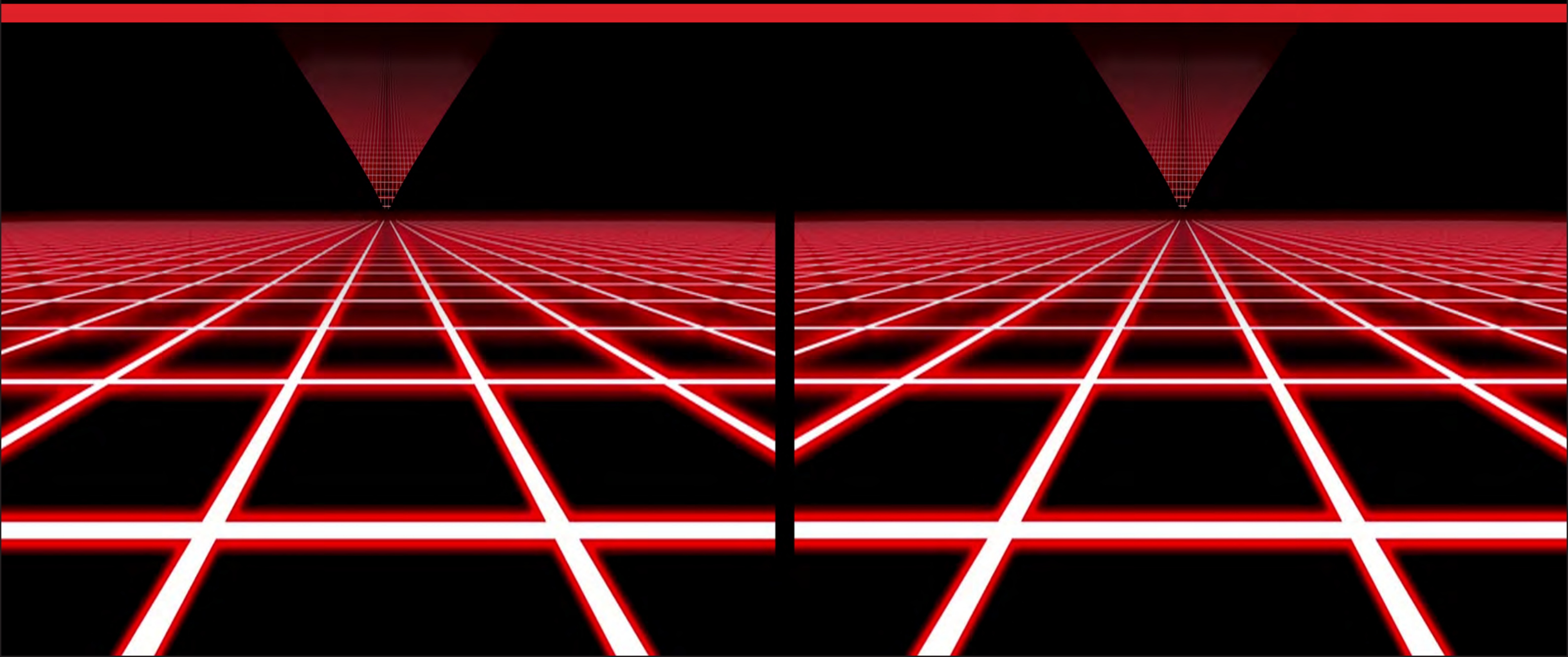

- └ Abrasives & Cleaning 2 - 5
- └ Polishing 6 -10
- └ Air Tools 11-15
- └ Compressors & Dryers 16-17
- └ Power Tools 18-25
- └ Hand Tools & Dollies 26-30
- └ Pulling Clamps 31-33
- └ Car Lifts & Dollies 34-37
- └ Panel Stands & Parts Racks 38-41
- └ Floor Rack 42-44
- └ Tapes & Masking 45-47
- └ Mixing Cups & Liners 48-49
- └ Filters 50-52
- └ Spray Booth 53
- └ Dust Extraction 54-56
- └ Plastic Repair 57
- └ Dent Puller 58-61
- └ Spot Welder & MIG's 62-63
- └ Infrared & UVA LED Paint Curing Systems 64-67
- └ Tool Cabinets & Workbenches 68-71
- └ Solvent - Recyclers 72-75
- └ Solvent - Spray Gun & Pot Cleaners 76-78
- └ Waterborne - Recyclers, Waterborne - Spray Gun & Pot Cleaners 78-81
- └ Matrix Wand 82
- └ Wheel Aligner 83
- └ Bumper Sensor Kits 84-85
- └ Andreae 86
- └ Bossauto 87-88
- └ Etalon 89-91
- └ Fy-Tech 92-94
- └ Induction 95
- └ Meguro 96
- └ MWM 97
- └ Planit 98-101
- └ Stucchi 102
- └ Uniram 103-104

- 2 - 5 Abrasives & Cleaning
- 6 -10 Polishing
- 11-15 Air Tools
- 16-17 Compressors & Dryers
- 18-25 Power Tools
- 26-30 Hand Tools & Dollies
- 31-33 Pulling Clamps
- 34-37 Car Lifts & Dollies
- 38-41 Panel Stands & Parts Racks
- 42-44 Floor Rack
- 45-47 Tapes & Masking
- 48-49 Mixing Cups & Liners
- 50-52 Filters
- 53 Spray Booth
- 54-56 Dust Extraction
- 57 Plastic Repair
- 58-61 Dent Puller
- 62-63 Spot Welder & MIG's
- 64-67 Infrared & UVA LED Paint Curing Systems
- 68-71 Tool Cabinets & Workbenches
- 72-75 Solvent - Recyclers
- 76-78 Solvent - Spray Gun & Pot Cleaners
- 78-81 Waterborne - Recyclers Waterborne - Spray Gun & Pot Cleaners
- 82 Matrix Wand
- 83 Wheel Aligner
- 84-85 Bumper Sensor Kits
- 86 Andreae
- 87-88 Bossauto
- 89-91 Etalon
- 92-94 Fy-Tech
- 95 Induction
- 96 Meguro
- 97 MWM
- 98-101 Planit
- 102 Stucchi
- 103-104 Uniram



ORIGINALLY ESTABLISHED IN 2004 BLACKLINE AUSTRALASIA IS A FAMILY OWNED AND OPERATED COMPANY WHICH HAS GROWN LEAPS AND BOUNDS BY ESTABLISHING TRUSTED BUSINESS RELATIONSHIPS WITH CUSTOMERS AND INTERNATIONAL PARTNERS WHO KNOW THEY WILL RECEIVE THE BEST QUALITY PRODUCTS AND SERVICE FROM BLACKLINE AUSTRALASIA.

AT BLACKLINE AUSTRALASIA OUR STRONG WORK ETHICS HAS GAINED US INTERNATIONAL RESPECT AND WE ARE HIGHLY REGARDED BY OUR OVERSEAS PARTNERS FOR OUR HONESTY, LOYALTY AND INTEGRITY. WE HAVE A SOLID CUSTOMER BASE, ARE CLIENT FOCUSED AND WORK TIRELESSLY TO MAKE SURE WE MEET CUSTOMER NEEDS. WE SUPPLY QUALITY PRODUCTS TO THE AUTOMOTIVE REFINISHING, PAINT, PANEL, FLEET, UTILITY, AEROSPACE, MARINE AND MANUFACTURING INDUSTRIES.

WE IMPORT AND STOCK OVER 2000 INVENTORY ITEMS AND ARE AUSTRALIA'S SOLE PARTNERS OF MAJOR BRANDS SUCH AS UNIRAM, FY-TECH, MEGURO, ASTRA SPAIN, PLANIT, INDUCTION INC, ETALON AND STUCCHI, AS WELL AS PROVIDING PRODUCTS FROM, BOSSAUTO, ANDREAЕ, MWM, TJG AUTO TOOLS, MATRIX AND MANY MORE.

HAVING USED AND TESTED OUR PRODUCTS WE PROVIDE OUR CUSTOMERS WITH THEIR OWN CUSTOM BRANDED PRODUCTS (OEM).

BLACKLINE AUSTRALASIA ARE ALWAYS HAPPY TO TALK TO NEW DISTRIBUTORS SO FEEL FREE TO CONTACT US.



## Abrasives & Cleaning

Abrasives & Cleaning	2 - 5
Polishing	6 -10
Air Tools	11-15
Compressors & Dryers	16-17
Power Tools	18-25
Hand Tools & Dollys	26-30
Pulling Clamps	31-33
Car Lifts & Dollys	34-37
Panel Stands & Parts Racks	38-41
Floor Rack	42-44
Tapes & Masking	45-47
Mixing Cups & Liners	48-49
Filters	50-52
Spray Booth	53
Dust Extraction	54-56
Plastic Repair	57
Dent Puller	58-61
Spot Welder & MIG's	62-63
Infrared & UVA LED Paint Curing Systems	64-67
Tool Cabinets & Workbenches	68-71
Solvent - Recyclers	72-75
Solvent - Spray Gun & Pot Cleaners	76-78
Waterborne - Recyclers, Waterborne - Spray Gun & Pot Cleaners	78-81
Matrix Wand	82
Wheel Aligner	83
Bumper Sensor Kits	84-85
Andreae	86
Bossauto	87-88
Etalon	89-91
Fy-Tech	92-94
Induction	95
Meguro	96
MWM	97
Planit	98-101
Stucchi	102
Uniram	103-104



Flat Flexible File with Holes

9 Tooth File  
SKU: BLP127-005

14 Tooth File  
SKU: BLP127-007

For use on its own or attached to the Abrasive File Holder below.



Abrasive File Holder  
SKU: BLP125-009

For use with abrasive files. Including Flat Flexible File Above.



Slapping File Coarse  
SKU: BLP127-002

Used to shrink stretched metal and highlight low spots. An old-time secret for removing dents and/or smoothing body work on hand fabricated panels. The serrated face works in two ways:

Shrinks the stretched metal. Highlights high/low spots that require hammer and dolly work.



Flexible Velcro Hand Block  
SKU: ETVHB70400PL

70 x 400mm Flexible Velcro hand block for abrasive strips, ideal for sanding of large surfaces, slightly curved.

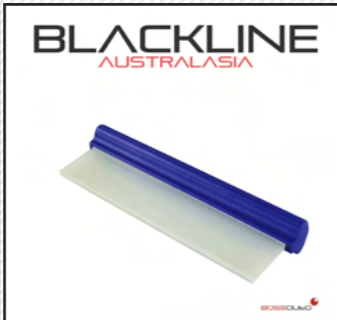

Silicone Blade  
SKU: BOS100067

30cm Blade useful for drying all surfaces. Save time with its flexibility and adaptability to all surface types.

## Abrasives & Cleaning

Abrasives & Cleaning	2 - 5
Polishing	6 -10
Air Tools	11-15
Compressors & Dryers	16-17
Power Tools	18-25
Hand Tools & Dollys	26-30
Pulling Clamps	31-33
Car Lifts & Dollys	34-37
Panel Stands & Parts Racks	38-41
Floor Rack	42-44
Tapes & Masking	45-47
Mixing Cups & Liners	48-49
Filters	50-52
Spray Booth	53
Dust Extraction	54-56
Plastic Repair	57
Dent Puller	58-61
Spot Welder & MIG's	62-63
Infrared & UVA LED Paint Curing Systems	64-67
Tool Cabinets & Workbenches	68-71
Solvent - Recyclers	72-75
Solvent - Spray Gun & Pot Cleaners	76-78
Waterborne - Recyclers Waterborne - Spray Gun & Pot Cleaners	78-81
Matrix Wand	82
Wheel Aligner	83
Bumper Sensor Kits	84-85
Andreae	86
Bossauto	87-88
Etalon	89-91
Fy-Tech	92-94
Induction	95
Meguro	96
MWM	97
Planit	98-101
Stucchi	102
Uniram	103-104

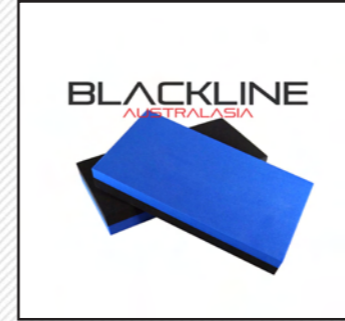

Blue Sanding Block  
SKU: BLP2H-210

For use with sandpaper, the blue sanding block is harder than the Red Sanding Block.

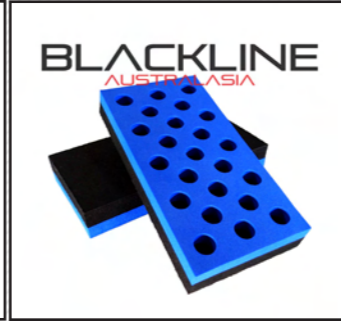

Blue Sanding Block with Holes  
SKU: BLP2H-210B

For Use with sandpapers.



Red Sanding Block  
SKU: BLP2H-210A

For use with sandpaper, the red sanding block is softer than the Blue Sanding Block.



Iron Mask  
SKU: BOS100073

3 pack Stainless steel masking stencil to prevent rub-through when sanding or shaving minor surface imperfections.



Dust Cutting Metal Blade  
SKU: BOS100042

3mm Rectangular blade of stainless steel hardened on the flat edges. Perfectly rectangular. This scraping blade especially designed for removing loose particles and dust blemishes, for quick elimination of these imperfections.



Nylon Sealer Brush  
SKU: BOS050003

Brush with nylon bristles, designed for the application of sealers.



Velcro Sanding Block Set  
SKU: PI031-069

x1 Flat Pilot Sanding Block  
x1 Edge Sanding Block  
x2 Convex Shape Sanding Block  
x2 Convex Shape Sanding Block

Comes with a handy carry case.



## Abrasives & Cleaning

- Abrasives & Cleaning 2-5
- Polishing 6-10
- Air Tools 11-15
- Compressors & Dryers 16-17
- Power Tools 18-25
- Hand Tools & Dollys 26-30
- Pulling Clamps 31-33
- Car Lifts & Dollys 34-37
- Panel Stands & Parts Racks 38-41
- Floor Rack 42-44
- Tapes & Masking 45-47
- Mixing Cups & Liners 48-49
- Filters 50-52
- Spray Booth 53
- Dust Extraction 54-56
- Plastic Repair 57
- Dent Puller 58-61
- Spot Welder & MIG's 62-63
- Infrared & UVA LED Paint Curing Systems 64-67
- Tool Cabinets & Workbenches 68-71
- Solvent - Recyclers 72-75
- Solvent - Spray Gun & Pot Cleaners 76-78
- Waterborne - Recyclers, Waterborne - Spray Gun & Pot Cleaners 78-81
- Matrix Wand 82
- Wheel Aligner 83
- Bumper Sensor Kits 84-85
- Andreae 86
- Bossauto 87-88
- Etalon 89-91
- Fy-Tech 92-94
- Induction 95
- Meguro 96
- MWM 97
- Planit 98-101
- Stucchi 102
- Uniram 103-104



**Abrasive Sponge Sanding Pads**  
 (115 X 140 X 5mm) FINE – **BOS060161**  
 (115 X 140 X 5mm) MEDIUM – **BOS060160**  
 (115 X 140 X 5mm) MICROFINE – **BOS060163**  
 (115 X 140 X 5mm) SUPERFINE – **BOS060162**

The composition and size of these abrasive sponges allow access to difficult to access body parts, producing a finer and smoother surface quality. Pack of 20 pads.



**Clay Cloth**  
SKU: BLP CLOTH

A revolutionary alternative to the clay bar. Features a 12"x12" microfiber cloth with a polymer rubber later bonded to the side. Just fold the towel into a pad and you can remove all surface contamination on vehicles faster and more effectively than a clay bar. Can be rinsed and reused numerous times.

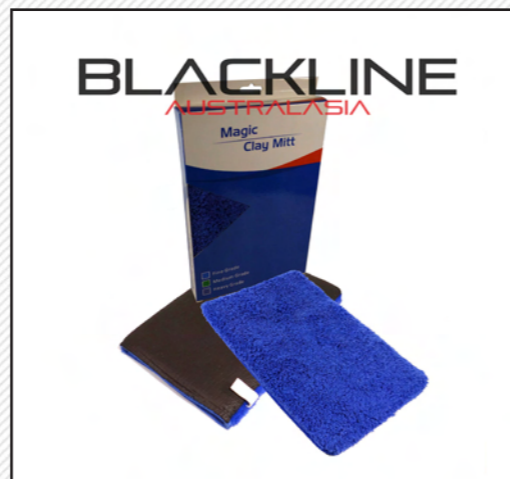

**Clay Mitt**  
SKU: BLP C MITT

Features an advanced polymer rubber layer bond to one side. Just wet the vehicle paint and you can remove all surface embedded contamination faster and more effectively than a clay bar. Can be rinsed and reused numerous times.



**Clay Disk**  
SKU: BLP C DISK

A revolutionary alternative to the clay bar and traditional polishing pad.



**Tack Cloth Basecoat 20box**  
SKU: BLP27-800

Box of 20 Tack Cloths for removing dust and fine particles.

## Abrasives & Cleaning

- Abrasives & Cleaning 2-5
- Polishing 6-10
- Air Tools 11-15
- Compressors & Dryers 16-17
- Power Tools 18-25
- Hand Tools & Dollys 26-30
- Pulling Clamps 31-33
- Car Lifts & Dollys 34-37
- Panel Stands & Parts Racks 38-41
- Floor Rack 42-44
- Tapes & Masking 45-47
- Mixing Cups & Liners 48-49
- Filters 50-52
- Spray Booth 53
- Dust Extraction 54-56
- Plastic Repair 57
- Dent Puller 58-61
- Spot Welder & MIG's 62-63
- Infrared & UVA LED Paint Curing Systems 64-67
- Tool Cabinets & Workbenches 68-71
- Solvent - Recyclers 72-75
- Solvent - Spray Gun & Pot Cleaners 76-78
- Waterborne - Recyclers, Waterborne - Spray Gun & Pot Cleaners 78-81
- Matrix Wand 82
- Wheel Aligner 83
- Bumper Sensor Kits 84-85
- Andreae 86
- Bossauto 87-88
- Etalon 89-91
- Fy-Tech 92-94
- Induction 95
- Meguro 96
- MWM 97
- Planit 98-101
- Stucchi 102
- Uniram 103-104



**Eraser Pad**  
SKU: BLP5PTW



**Caramel Eraser Wheel with Arbor**  
SKU: BLP5P64



**Joybond Clar Bar Red**  
SKU: BLPB691A

More abrasive than the Blue Clay Bar. Ideal for removing paint mist and brake dust, off wheels.



**Joybond Clar Bar Blue**  
SKU: BLPB691B

Our standard cleaning clay. It removes surface contaminants such as brake dust, road tar, tree sap and industrial falls. Ideal for preparation of coatings.



## Polishing

- └ Abrasives & Cleaning 2 - 5
- └ Polishing 6 - 10
- └ Air Tools 11-15
- └ Compressors & Dryers 16-17
- └ Power Tools 18-25
- └ Hand Tools & Dollies 26-30
- └ Pulling Clamps 31-33
- └ Car Lifts & Dollies 34-37
- └ Panel Stands & Parts Racks 38-41
- └ Floor Rack 42-44
- └ Tapes & Masking 45-47
- └ Mixing Cups & Liners 48-49
- └ Filters 50-52
- └ Spray Booth 53
- └ Dust Extraction 54-56
- └ Plastic Repair 57
- └ Dent Puller 58-61
- └ Spot Welder & MIG's 62-63
- └ Infrared & UVA LED Paint Curing Systems 64-67
- └ Tool Cabinets & Workbenches 68-71
- └ Solvent - Recyclers 72-75
- └ Solvent - Spray Gun & Pot Cleaners 76-78
- └ Waterborne - Recyclers, Waterborne - Spray Gun & Pot Cleaners 78-81
- └ Matrix Wand 82
- └ Wheel Aligner 83
- └ Bumper Sensor Kits 84-85
- └ Andreae 86
- └ Bossauto 87-88
- └ Etalon 89-91
- └ Fy-Tech 92-94
- └ Induction 95
- └ Meguro 96
- └ MWM 97
- └ Planit 98-101
- └ Stucchi 102
- └ Uniram 103-104



**Absolute Cut Compound**  
SKU: ET1010

Cuts and polishes in a one step action. Extra cut compound is designed for the most demanding polishing tasks, removes scratches from abrasive P1500 and leaves a deep glossy surface.

1kg.



**Fast Cut Compound 1**  
SKU: ET1001

Perfect for paint runs, dust nibs, "orange peel" and deep scratches

1Kg



**Absolute Compound**  
SKU: ET2010

Ultimate one-step polishing compound suitable for the fast removal of scratches. Excellent hologram free gloss on dark colors and scratch-resistant coatings. Recommended for polishing freshly painted cars.

1Liter



**Machine Polish III**  
SKU: ET1003

New anti-hologram formulation. Enhances gloss without leaving swirls.

1 liter



**Finishing Glaze**  
SKU: ET1004

Non abrasive polishing glaze with a specially designed formula that penetrates paint and creates an invisible thin protective film on the polished surface.

500ml



**Metal Polish**  
SKU: ETMET930750

Polish for all metal parts: chrome, brass, copper, nickel, stainless steel and other surfaces. Cleans, polishes, removes rust and leaves protective film.

750ml

## Polishing

- └ Abrasives & Cleaning 2 - 5
- └ Polishing 6 - 10
- └ Air Tools 11-15
- └ Compressors & Dryers 16-17
- └ Power Tools 18-25
- └ Hand Tools & Dollies 26-30
- └ Pulling Clamps 31-33
- └ Car Lifts & Dollies 34-37
- └ Panel Stands & Parts Racks 38-41
- └ Floor Rack 42-44
- └ Tapes & Masking 45-47
- └ Mixing Cups & Liners 48-49
- └ Filters 50-52
- └ Spray Booth 53
- └ Dust Extraction 54-56
- └ Plastic Repair 57
- └ Dent Puller 58-61
- └ Spot Welder & MIG's 62-63
- └ Infrared & UVA LED Paint Curing Systems 64-67
- └ Tool Cabinets & Workbenches 68-71
- └ Solvent - Recyclers 72-75
- └ Solvent - Spray Gun & Pot Cleaners 76-78
- └ Waterborne - Recyclers Waterborne - Spray Gun & Pot Cleaners 78-81
- └ Matrix Wand 82
- └ Wheel Aligner 83
- └ Bumper Sensor Kits 84-85
- └ Andreae 86
- └ Bossauto 87-88
- └ Etalon 89-91
- └ Fy-Tech 92-94
- └ Induction 95
- └ Meguro 96
- └ MWM 97
- └ Planit 98-101
- └ Stucchi 102
- └ Uniram 103-104



150mm Backing Plate  
SKU: PI-TDAB

150mm Backing Plate for Dual Action Polisher



Back Up Pad 6inch Velcro 6 holes  
SKU: BLPUF-662



Joybond Clar Bar Red  
SKU: BLPB691A

More abrasive than the Blue Clay Bar. Ideal for removing paint mist and brake dust, off wheels.



3"Air Angle Sander & Polisher  
SKU: PICO128-047

3 inch Air Angle Sander and Polisher

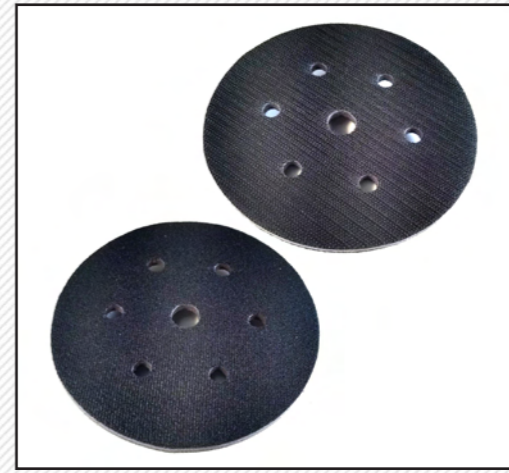

Interface Pad Soft Velcro 5mm  
SKU: BLP60620-10



Joybond Clar Bar Blue  
SKU: BLPB691B

Our standard cleaning clay. It removes surface contaminants such as brake dust, road tar, tree sap and industrial falls. Ideal for preparation of coatings.



## Polishing

- └ Abrasives & Cleaning 2 - 5
- └ Polishing 6 - 10
- └ Air Tools 11-15
- └ Compressors & Dryers 16-17
- └ Power Tools 18-25
- └ Hand Tools & Dollies 26-30
- └ Pulling Clamps 31-33
- └ Car Lifts & Dollies 34-37
- └ Panel Stands & Parts Racks 38-41
- └ Floor Rack 42-44
- └ Tapes & Masking 45-47
- └ Mixing Cups & Liners 48-49
- └ Filters 50-52
- └ Spray Booth 53
- └ Dust Extraction 54-56
- └ Plastic Repair 57
- └ Dent Puller 58-61
- └ Spot Welder & MIG's 62-63
- └ Infrared & UVA LED Paint Curing Systems 64-67
- └ Tool Cabinets & Workbenches 68-71
- └ Solvent - Recyclers 72-75
- └ Solvent - Spray Gun & Pot Cleaners 76-78
- └ Waterborne - Recyclers, Waterborne - Spray Gun & Pot Cleaners 78-81
- └ Matrix Wand 82
- └ Wheel Aligner 83
- └ Bumper Sensor Kits 84-85
- └ Andreae 86
- └ Bossauto 87-88
- └ Etalon 89-91
- └ Fy-Tech 92-94
- └ Induction 95
- └ Meguro 96
- └ MWM 97
- └ Planit 98-101
- └ Stucchi 102
- └ Uniram 103-104



**Rotary Polishing Buff**  
**SKU: PI-SRBV**  
 240V 50Hz 1150W  
 Speed: 1000-3500r/min  
 Pad Size: 150mm  
 Rotary M14



**Dual Action Polisher**  
**SKU: PI-TDAB**  
 Dual Action Electric Polisher

## Polishing

- └ Abrasives & Cleaning 2 - 5
- └ Polishing 6 - 10
- └ Air Tools 11-15
- └ Compressors & Dryers 16-17
- └ Power Tools 18-25
- └ Hand Tools & Dollies 26-30
- └ Pulling Clamps 31-33
- └ Car Lifts & Dollies 34-37
- └ Panel Stands & Parts Racks 38-41
- └ Floor Rack 42-44
- └ Tapes & Masking 45-47
- └ Mixing Cups & Liners 48-49
- └ Filters 50-52
- └ Spray Booth 53
- └ Dust Extraction 54-56
- └ Plastic Repair 57
- └ Dent Puller 58-61
- └ Spot Welder & MIG's 62-63
- └ Infrared & UVA LED Paint Curing Systems 64-67
- └ Tool Cabinets & Workbenches 68-71
- └ Solvent - Recyclers 72-75
- └ Solvent - Spray Gun & Pot Cleaners 76-78
- └ Waterborne - Recyclers Waterborne - Spray Gun & Pot Cleaners 78-81
- └ Matrix Wand 82
- └ Wheel Aligner 83
- └ Bumper Sensor Kits 84-85
- └ Andreae 86
- └ Bossauto 87-88
- └ Etalon 89-91
- └ Fy-Tech 92-94
- └ Induction 95
- └ Meguro 96
- └ MWM 97
- └ Planit 98-101
- └ Stucchi 102
- └ Uniram 103-104



**3in1 Headlight Repair Kit**  
**SKU: ETKIT3IN1**

ETALON 3 in 1 kit for headlights, transparent plastics, motorcycle or boat plastic windshield & painted parts, such as car mirrors or bumpers restoration.

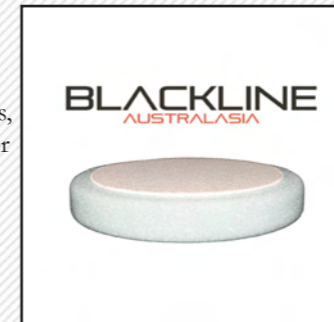

**White Diamond Polishing Pad**  
**SKU: ET1502500**  
 150 x 25mm  
 Polishing pad with advanced cutting properties for the most demanding jobs.



**Top Inspection Spray**  
**SKU: ETTOP007**  
 Spray for effective inspection of compounding processes. Perfect for cleaning of compound residues & for thorough inspection of the polishing process prior to next step. Safe on all paint surfaces.



**Hard Blue Polishing Pad**  
**SKU: ET1505002**  
 150 x 50mm  
 For use with ET1001 Fast Cut Compound, specifically for the removal of paint defects and deep scratches. Ideal for the compounding of old and new coatings.



**Microfiber Cloth**  
**SKU: ETMICRO01**  
 Microfiber cloth for cleaning & polishing. Extraordinary for removal of polishing compound residues, cleaning & drying of the surface. Does not scratch surfaces.



**Microfiber Cloth 2in1**  
**SKU: ETMICRO02**  
 Orange 2in1 double-sided microfiber cloth. The long threaded side is ideal for removing polishing compounds' residues. While the short threaded side is ideal for the final finish after polishing.



## Polishing

- └ Abrasives & Cleaning 2-5
- └ Polishing 6-10
- └ Air Tools 11-15
- └ Compressors & Dryers 16-17
- └ Power Tools 18-25
- └ Hand Tools & Dollys 26-30
- └ Pulling Clamps 31-33
- └ Car Lifts & Dollys 34-37
- └ Panel Stands & Parts Racks 38-41
- └ Floor Rack 42-44
- └ Tapes & Masking 45-47
- └ Mixing Cups & Liners 48-49
- └ Filters 50-52
- └ Spray Booth 53
- └ Dust Extraction 54-56
- └ Plastic Repair 57
- └ Dent Puller 58-61
- └ Spot Welder & MIG's 62-63
- └ Infrared & UVA LED Paint Curing Systems 64-67
- └ Tool Cabinets & Workbenches 68-71
- └ Solvent - Recyclers 72-75
- └ Solvent - Spray Gun & Pot Cleaners 76-78
- └ Waterborne - Recyclers, Waterborne - Spray Gun & Pot Cleaners 78-81
- └ Matrix Wand 82
- └ Wheel Aligner 83
- └ Bumper Sensor Kits 84-85
- └ Andreae 86
- └ Bossauto 87-88
- └ Etalon 89-91
- └ Fy-Tech 92-94
- └ Induction 95
- └ Meguro 96
- └ MWM 97
- └ Planit 98-101
- └ Stucchi 102
- └ Uniram 103-104



**Soft Black Profiled Polishing Pad**  
SKU: ET1502505

150 x 25mm  
Provides excellent holograms free finish with ET1003 & ET1004.



**Super Soft Black Polishing Pad**  
SKU: ET1505004

150 x 50mm  
Guaranties high performance in application with ET1003 & ET1004 for removal of holograms & for gloss enhancing.



**100mm Foam Polishing Ball**  
SKU: ETFBALL100

Especially designed to reach and polish car parts that are hard to access, like rims, headlights, motorcycle and boat accessories. Very effective on sensitive metals and painted surfaces. To be used with ordinary drill.

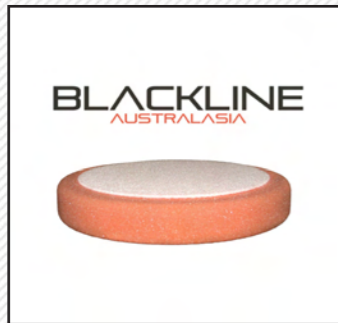

**Orange Universal Polishing Pad Small & Large**  
Small SKU: ET0762503 (76 x 25mm)  
Large SKU: ET1505003 (150 x 50mm)

Versatile medium density pad for minor scratches, imperfections and polishing.



**Wool Polishing Ball**  
SKU: ETWBALL76

76mm  
Natural twisted wool polishing ball, especially designed to reach and polish car parts that are hard to access, like rims, headlights, motorcycle and boat accessories. Very effective on weathered and oxidized surfaces.



**Wool Pad 6 Inch**  
SKU: BLP8VLW

6 Inch Wool Pad, made from 100% Wool and secured with single sided Velcro is a great option for polishing jobs.



**Dry Control Powder**  
SKU: ETDG-00B

Dry guide coat to reveal surface defects. Excellent results during either wet or dry sanding.

## Air Tools

- └ Abrasives & Cleaning 2-5
- └ Polishing 6-10
- └ Air Tools 11-15
- └ Compressors & Dryers 16-17
- └ Power Tools 18-25
- └ Hand Tools & Dollys 26-30
- └ Pulling Clamps 31-33
- └ Car Lifts & Dollys 34-37
- └ Panel Stands & Parts Racks 38-41
- └ Floor Rack 42-44
- └ Tapes & Masking 45-47
- └ Mixing Cups & Liners 48-49
- └ Filters 50-52
- └ Spray Booth 53
- └ Dust Extraction 54-56
- └ Plastic Repair 57
- └ Dent Puller 58-61
- └ Spot Welder & MIG's 62-63
- └ Infrared & UVA LED Paint Curing Systems 64-67
- └ Tool Cabinets & Workbenches 68-71
- └ Solvent - Recyclers 72-75
- └ Solvent - Spray Gun & Pot Cleaners 76-78
- └ Waterborne - Recyclers Waterborne - Spray Gun & Pot Cleaners 78-81
- └ Matrix Wand 82
- └ Wheel Aligner 83
- └ Bumper Sensor Kits 84-85
- └ Andreae 86
- └ Bossauto 87-88
- └ Etalon 89-91
- └ Fy-Tech 92-94
- └ Induction 95
- └ Meguro 96
- └ MWM 97
- └ Planit 98-101
- └ Stucchi 102
- └ Uniram 103-104



**Stat Gun**  
SKU: BOSSTATGUN

By using the Stat-Gun on every job, between every coat, you can:

- Reduce dust and dirt inclusions
- Reduce halo blending effect and mottling
- Reduce the amount of paint material used
- Improve color matching, film flow and metallic lay down
- Increase throughput
- Increase your profitability by reducingre work time
- Increase job satisfaction by achieving a perfect finish every time



**Vacuum Sanding Kit**  
SKU: PISBK5PC

Comes in a hard case. Use 5pcs Vacuum Sanding Kit with Hook and Loop Sanding papers.



**Wind Jet Blower**  
Small SKU: BLP108-011

Using the Wind Jet Blower you can create a steady stream of air that can be used in drying applications.



**Pocket Blow Gun Universal**  
SKU: BLP108-005

Handy Universal blow gun attachment.



**Pocket Blow Gun Japan Type**  
SKU: BLP108-009

Handy Universal blow gun attachment.



**Air Tools**

- └ Abrasives & Cleaning 2 - 5
- └ Polishing 6 -10
- └ **Air Tools 11-15**
- └ Compressors & Dryers 16-17
- └ Power Tools 18-25
- └ Hand Tools & Dollys 26-30
- └ Pulling Clamps 31-33
- └ Car Lifts & Dollys 34-37
- └ Panel Stands & Parts Racks 38-41
- └ Floor Rack 42-44
- └ Tapes & Masking 45-47
- └ Mixing Cups & Liners 48-49
- └ Filters 50-52
- └ Spray Booth 53
- └ Dust Extraction 54-56
- └ Plastic Repair 57
- └ Dent Puller 58-61
- └ Spot Welder & MIG's 62-63
- └ Infrared & UVA LED Paint Curing Systems 64-67
- └ Tool Cabinets & Workbenches 68-71
- └ Solvent - Recyclers 72-75
- └ Solvent - Spray Gun & Pot Cleaners 76-78
- └ Waterborne - Recyclers, Waterborne - Spray Gun & Pot Cleaners 78-81
- └ Matrix Wand 82
- └ Wheel Aligner 83
- └ Bumper Sensor Kits 84-85
- └ Andreae 86
- └ Bossauto 87-88
- └ Etalon 89-91
- └ Fy-Tech 92-94
- └ Induction 95
- └ Meguro 96
- └ MWM 97
- └ Planit 98-101
- └ Stucchi 102
- └ Uniram 103-104



 <b>GTI ADAPTOR</b> SKU: PIT08020	 <b>IWATA ADAPTOR</b> SKU: PIT08021	 <b>SATA ADAPTOR</b> SKU: PIT08022	 <b>SATA QUICK RELEASE ADAPTOR</b> SKU: PIT08023
--	--	--	---

GTI Adaptor SKU: PIT08020	IWATA Adaptor SKU: PIT08021	SATA Adaptor SKU: PIT08022	SATA Quick Release Adaptor SKU: PIT08023
------------------------------	--------------------------------	-------------------------------	---



**3" Air Palm Sander/Denibber**  
SKU: PI00128-050



**5 pcs Gravity Filters**  
SKU: BLP120-017

Comes in pack of 5

**Air Tools**

- 2 - 5 Abrasives & Cleaning
- 6 -10 Polishing
- 11-15 **Air Tools**
- 16-17 Compressors & Dryers
- 18-25 Power Tools
- 26-30 Hand Tools & Dollys
- 31-33 Pulling Clamps
- 34-37 Car Lifts & Dollys
- 38-41 Panel Stands & Parts Racks
- 42-44 Floor Rack
- 45-47 Tapes & Masking
- 48-49 Mixing Cups & Liners
- 50-52 Filters
- 53 Spray Booth
- 54-56 Dust Extraction
- 57 Plastic Repair
- 58-61 Dent Puller
- 62-63 Spot Welder & MIG's
- 64-67 Infrared & UVA LED Paint Curing Systems
- 68-71 Tool Cabinets & Workbenches
- 72-75 Solvent - Recyclers
- 76-78 Solvent - Spray Gun & Pot Cleaners
- 78-81 Waterborne - Recyclers Waterborne - Spray Gun & Pot Cleaners
- 82 Matrix Wand
- 83 Wheel Aligner
- 84-85 Bumper Sensor Kits
- 86 Andreae
- 87-88 Bossauto
- 89-91 Etalon
- 92-94 Fy-Tech
- 95 Induction
- 96 Meguro
- 97 MWM
- 98-101 Planit
- 102 Stucchi
- 103-104 Uniram



**1 Gun Holder Magnetic**  
SKU: BLP038-001



**2 Gun Holder Magnetic Small**  
SKU: BLP038-007

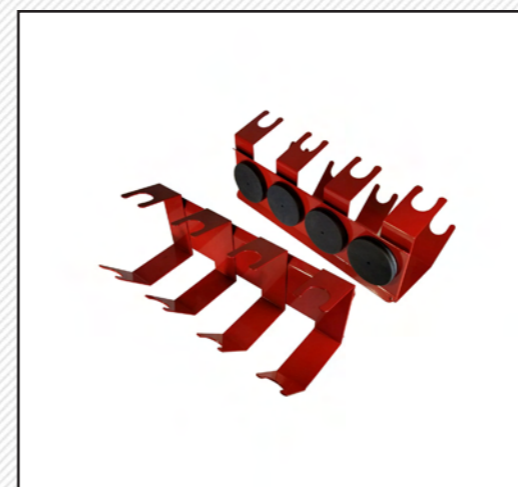

**4 Gun Holder Magnetic**  
SKU: BLP038-008



**17 pcs Gun Cleaning Kit**  
SKU: BLP120-022

- Contains:
- 1 x Single-handed brush
  - 3 x Black Nylon Brushes
  - 5 x Mini Nylon Brush Set
  - 1 x White Tube Brush
  - 1 x Surface Nylon Brush
  - 6 x Nozzle Cleaning Needles





**Air Tools**

- └ Abrasives & Cleaning 2 - 5
- └ Polishing 6 -10
- └ **Air Tools 11-15**
- └ Compressors & Dryers 16-17
- └ Power Tools 18-25
- └ Hand Tools & Dollys 26-30
- └ Pulling Clamps 31-33
- └ Car Lifts & Dollys 34-37
- └ Panel Stands & Parts Racks 38-41
- └ Floor Rack 42-44
- └ Tapes & Masking 45-47
- └ Mixing Cups & Liners 48-49
- └ Filters 50-52
- └ Spray Booth 53
- └ Dust Extraction 54-56
- └ Plastic Repair 57
- └ Dent Puller 58-61
- └ Spot Welder & MIG's 62-63
- └ Infrared & UVA LED Paint Curing Systems 64-67
- └ Tool Cabinets & Workbenches 68-71
- └ Solvent - Recyclers 72-75
- └ Solvent - Spray Gun & Pot Cleaners 76-78
- └ Waterborne - Recyclers, Waterborne - Spray Gun & Pot Cleaners 78-81
- └ Matrix Wand 82
- └ Wheel Aligner 83
- └ Bumper Sensor Kits 84-85
- └ Andreae 86
- └ Bossauto 87-88
- └ Etalon 89-91
- └ Fy-Tech 92-94
- └ Induction 95
- └ Meguro 96
- └ MWM 97
- └ Planit 98-101
- └ Stucchi 102
- └ Uniram 103-104



**6" Air Orbital Sander 2.5mm**  
SKU: PICO128-044

6" Air Powered Orbital Sander 2.5mm with Central Vacuum  
Pad Size: 150mm/ 6inch  
Free Speed: 10,500rpm  
Average Air Consumption: 3cfm@90psi  
Air Inlet: 1/4inch.  
Weight: 0.96kg



**6" Air Palm Sander 5.0mm**  
Small SKU: PICO128-045

6" Air Powered Palm Sander 5.0mm with Central Vacuum  
Pad Size: 6 inch / 1500mm  
Free Speed: 10,500RPM  
Average Air Consumption: 3cfm@90psi  
Air Inlet: 1/4inch  
Weight: 0.96



**3" Air Palm Sander/Denibber**  
SKU: PICO128-048

3" Air Palm Sander / Denibber  
Free Speed: 16,000rpm  
Average Air Consumption: 4cfm@90psi  
Air Inlet: 1/4inch  
Weight: 0.66kg



**Mini Air Die Grinder & Eraser Stripping Tool**  
SKU: PICO128-052

1/4inch 6mm Mini Air Die Grinder Eraser Stripping Tool  
Can use up to 5" size disks.  
Free Speed: 20,000rpm  
Average Air Consumption: 4cfm@90psi  
Air Inlet: 1/4inch.  
Weight: 0.66kg

**Air Tools**

- 2 - 5 Abrasives & Cleaning
- 6 -10 Polishing
- 11-15 **Air Tools**
- 16-17 Compressors & Dryers
- 18-25 Power Tools
- 26-30 Hand Tools & Dollys
- 31-33 Pulling Clamps
- 34-37 Car Lifts & Dollys
- 38-41 Panel Stands & Parts Racks
- 42-44 Floor Rack
- 45-47 Tapes & Masking
- 48-49 Mixing Cups & Liners
- 50-52 Filters
- 53 Spray Booth
- 54-56 Dust Extraction
- 57 Plastic Repair
- 58-61 Dent Puller
- 62-63 Spot Welder & MIG's
- 64-67 Infrared & UVA LED Paint Curing Systems
- 68-71 Tool Cabinets & Workbenches
- 72-75 Solvent - Recyclers
- 76-78 Solvent - Spray Gun & Pot Cleaners
- 78-81 Waterborne - Recyclers Waterborne - Spray Gun & Pot Cleaners
- 82 Matrix Wand
- 83 Wheel Aligner
- 84-85 Bumper Sensor Kits
- 86 Andreae
- 87-88 Bossauto
- 89-91 Etalon
- 92-94 Fy-Tech
- 95 Induction
- 96 Meguro
- 97 MWM
- 98-101 Planit
- 102 Stucchi
- 103-104 Uniram



**Air Drill Reversible 3/8"**  
SKU: PICO128-051

3/8" Air Drill Reversible with Chuck  
Free Speed: 18,000rpm  
Average Air Consumption: 20cfm@90psi  
Air Inlet: 1/4inch.  
Weight: 0.85kg



**Air Ratchet Mini Wrench**  
Small SKU: PICO128-053

1/4" Mini Air Ratchet Wrench  
Free Speed: 180rpm  
Average Air Consumption: 4cfm@90psi  
Air Inlet: 1/4inch  
Weight: 0.51kg



**Mini Disc Air Sander Kit with 4pcs**  
SKU: PICO128-049

Mini Disc Air Sander Kit with 4pcs  
Free Speed: 16,000rpm  
Average Air Consumption: 4cfm@90psi  
Air Inlet: 1/4inch.  
Weight: 0.66kg



**3" Air Angle Sander and Polisher**  
SKU: PICO128-047

3 inch Air Angle Sander and Polisher  
Free Speed: 5,000rpm  
Average Air Consumption: 3cfm@90psi  
Air Inlet: 1/4inch.  
Weight: 0.65kg



**Compressors & Dryers**

- └ Abrasives & Cleaning 2-5
- └ Polishing 6-10
- └ Air Tools 11-15
- └ **Compressors & Dryers 16-17**
- └ Power Tools 18-25
- └ Hand Tools & Dollies 26-30
- └ Pulling Clamps 31-33
- └ Car Lifts & Dollies 34-37
- └ Panel Stands & Parts Racks 38-41
- └ Floor Rack 42-44
- └ Tapes & Masking 45-47
- └ Mixing Cups & Liners 48-49
- └ Filters 50-52
- └ Spray Booth 53
- └ Dust Extraction 54-56
- └ Plastic Repair 57
- └ Dent Puller 58-61
- └ Spot Welder & MIG's 62-63
- └ Infrared & UVA LED Paint Curing Systems 64-67
- └ Tool Cabinets & Workbenches 68-71
- └ Solvent - Recyclers 72-75
- └ Solvent - Spray Gun & Pot Cleaners 76-78
- └ Waterborne - Recyclers, Waterborne - Spray Gun & Pot Cleaners 78-81
- └ Matrix Wand 82
- └ Wheel Aligner 83
- └ Bumper Sensor Kits 84-85
- └ Andreae 86
- └ Bossauto 87-88
- └ Etalon 89-91
- └ Fy-Tech 92-94
- └ Induction 95
- └ Meguro 96
- └ MWM 97
- └ Planit 98-101
- └ Stucchi 102
- └ Uniram 103-104



**Air Compressors 10P, 15P & 30P**  
SKU:FY-10P SKU:FY-15P SKU:FY-30P

- Highly intelligent control system ensures the reliability of automatic diagnosis, display, alarm and protection. Original TB oil filter ensures stable operation.
- Belt or coupling driving system provides quiet running, buffering and shock absorption.
- Original TPG easing valve assembly, more efficient and reliable.
- Specially designed air pre-filter keeps the inside parts clean, extends the maintenance cycle and is easy to remove and clean.
- Best screw main unit with high compression efficiency, saving energy up to 5%

**High-end configuration, energy efficient and environmentally friendly.**

- Use high efficient (energy efficiency level II) special motor for compressors as power system, longer service life and more efficient.
- Reasonable configurations for different power ranges, meet different air supply requirements.
- High-end configuration of oil-gas separator, lower oil content and more convenient to maintain.
- The minimum exhaust oil content is less than 2ppm, FY-Tech is committed to the creation of quality, micro-oil compressor made by oil-free technology is more energy efficient, quiet, reliable and has remarkable performance.

Model	SYEA-30P	SYEA-15P	SYEA-10P
Air Flow ( m <sup>3</sup> /min/MPa )	3.8/0.7	1.7/0.7	1.2/0.7
	3.6/0.8	1.6/0.8	1.1/0.8
	3.2/1.0	1.4/1.0	0.95/1.0
	2.9/1.2	1.2/1.2	0.8/1.2
Air Flow (kW)	22	11	7.5
Noise dB(A)	68±2	66 ± 2	66 ± 2
Outlet Diameter (Inch)	G1	G3/4	G1/2
Dimensions	L (mm)	1138	975
	W(mm)	850	825
	H(mm)	1230	1260
Weight ( kg )	680	405	245

**Compressors & Dryers**

- └ Abrasives & Cleaning 2-5
- └ Polishing 6-10
- └ Air Tools 11-15
- └ **Compressors & Dryers 16-17**
- └ Power Tools 18-25
- └ Hand Tools & Dollies 26-30
- └ Pulling Clamps 31-33
- └ Car Lifts & Dollies 34-37
- └ Panel Stands & Parts Racks 38-41
- └ Floor Rack 42-44
- └ Tapes & Masking 45-47
- └ Mixing Cups & Liners 48-49
- └ Filters 50-52
- └ Spray Booth 53
- └ Dust Extraction 54-56
- └ Plastic Repair 57
- └ Dent Puller 58-61
- └ Spot Welder & MIG's 62-63
- └ Infrared & UVA LED Paint Curing Systems 64-67
- └ Tool Cabinets & Workbenches 68-71
- └ Solvent - Recyclers 72-75
- └ Solvent - Spray Gun & Pot Cleaners 76-78
- └ Waterborne - Recyclers Waterborne - Spray Gun & Pot Cleaners 78-81
- └ Matrix Wand 82
- └ Wheel Aligner 83
- └ Bumper Sensor Kits 84-85
- └ Andreae 86
- └ Bossauto 87-88
- └ Etalon 89-91
- └ Fy-Tech 92-94
- └ Induction 95
- └ Meguro 96
- └ MWM 97
- └ Planit 98-101
- └ Stucchi 102
- └ Uniram 103-104

**AIR DRYERS**

**Small SKU: FY-15P-DRYER**  
**Large SKU: FY-30P-DRYER**

Highly efficient two-stage whirlwind & centrifugal gas-liquid separator with automatic drainage.

Can completely separate water from the compressed air.

15P	30P
Air flow: 2m <sup>3</sup> /min	3.8m <sup>3</sup> /min
Compressor: Power: 0.5HP	Power: 0.75HP
Input Voltage: 220/50V/Hz	220/50V/Hz
Pipe Diameter: 1"	1 1/2"
Dimensions: 750x420x730mm	930x500x800mm
Air Tank: 0.3m <sup>3</sup>	0.3m <sup>3</sup>
Weight: 65kg	92kg



**ALL IN ONE 10HP COMPRESSOR**  
SKU: FY-10HP-3IN1

Energy efficient & environmental friendly micro-oil screw Air Compressor Station with Dryer & 300 liter Air Tank.

– 300 liter Air Tank

- Intelligent control system can automatically diagnose, display, alarm and protect.
- Belt or coupling driving system provides quiet running, buffering and shock absorption.
- Best screw main unit with high compression efficiency, saving energy up to 5%
- Air-cool dryer with high efficient two-stage whirlwind and centrifugal gas-liquid separator with automatic drainage can completely separate water from the compressed air.
- High configuration, low-energy air compressor, energy efficient, energy saving and environmental protective.



**Power Tools**

- └ Abrasives & Cleaning 2 - 5
- └ Polishing 6 -10
- └ Air Tools 11-15
- └ Compressors & Dryers 16-17
- └ **Power Tools 18-25**
- └ Hand Tools & Dollies 26-30
- └ Pulling Clamps 31-33
- └ Car Lifts & Dollies 34-37
- └ Panel Stands & Parts Racks 38-41
- └ Floor Rack 42-44
- └ Tapes & Masking 45-47
- └ Mixing Cups & Liners 48-49
- └ Filters 50-52
- └ Spray Booth 53
- └ Dust Extraction 54-56
- └ Plastic Repair 57
- └ Dent Puller 58-61
- └ Spot Welder & MIG's 62-63
- └ Infrared & UVA LED Paint Curing Systems 64-67
- └ Tool Cabinets & Workbenches 68-71
- └ Solvent - Recyclers 72-75
- └ Solvent - Spray Gun & Pot Cleaners 76-78
- └ Waterborne - Recyclers, Waterborne - Spray Gun & Pot Cleaners 78-81
- └ Matrix Wand 82
- └ Wheel Aligner 83
- └ Bumper Sensor Kits 84-85
- └ Andreae 86
- └ Bossauto 87-88
- └ Etalon 89-91
- └ Fy-Tech 92-94
- └ Induction 95
- └ Meguro 96
- └ MWM 97
- └ Planit 98-101
- └ Stucchi 102
- └ Uniram 103-104



**Electric Palm Sander**  
Small SKU: PI-TW-AJ46

Random orbital sander is a powerful, variable speed machine, which works extremely well whilst being very comfortable to use.

- Quality hook and loop sanding pad
- Convenient variable speed control
- 6,000 – 12,000rpm
- Strong 450 watt motor
- Dust extraction port with collector
- Shipping Weight: 4kg



**Colour Matching Light & PEN in a Case**  
SKU: PI32036-1

Rechargeable work light with special COB LED for color matching and control of paint works,

Color Control 1w LED pen light for color matching and control, to detect scratches and stress marks, fits into every pocket.

**Power Tools**

- 2 - 5 Abrasives & Cleaning
- 6 -10 Polishing
- 11-15 Air Tools
- 16-17 Compressors & Dryers
- 18-25 **Power Tools**
- 26-30 Hand Tools & Dollies
- 31-33 Pulling Clamps
- 34-37 Car Lifts & Dollies
- 38-41 Panel Stands & Parts Racks
- 42-44 Floor Rack
- 45-47 Tapes & Masking
- 48-49 Mixing Cups & Liners
- 50-52 Filters
- 53 Spray Booth
- 54-56 Dust Extraction
- 57 Plastic Repair
- 58-61 Dent Puller
- 62-63 Spot Welder & MIG's
- 64-67 Infrared & UVA LED Paint Curing Systems
- 68-71 Tool Cabinets & Workbenches
- 72-75 Solvent - Recyclers
- 76-78 Solvent - Spray Gun & Pot Cleaners
- 78-81 Waterborne - Recyclers Waterborne - Spray Gun & Pot Cleaners
- 82 Matrix Wand
- 83 Wheel Aligner
- 84-85 Bumper Sensor Kits
- 86 Andreae
- 87-88 Bossauto
- 89-91 Etalon
- 92-94 Fy-Tech
- 95 Induction
- 96 Meguro
- 97 MWM
- 98-101 Planit
- 102 Stucchi
- 103-104 Uniram



**Dual Action Polisher**  
SKU: PI-TDAB

Dual Action Electric Polisher



**150mm Backing Plate**  
SKU: PI-TDAB

150mm Backing Plate for Dual Action Polisher  
PI-TDAB



**Heat Gun**  
SKU: PI-THGS 1

The Planit Heat Gun brings the heat at 350/550°C with 1000/2000w of power flowing at 300/500 L/min.



**Back Up Pad 6inch Velcro 6 holes**  
SKU: BLPUF-662

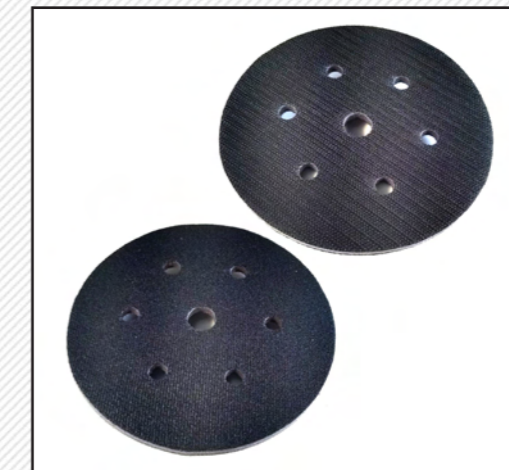

**Interface Pad Soft Velcro 5mm**  
SKU: BLP60620-10



**Power Tools**

- └ Abrasives & Cleaning 2 - 5
- └ Polishing 6 -10
- └ Air Tools 11-15
- └ Compressors & Dryers 16-17
- └ Power Tools 18-25
- └ Hand Tools & Dollies 26-30
- └ Pulling Clamps 31-33
- └ Car Lifts & Dollies 34-37
- └ Panel Stands & Parts Racks 38-41
- └ Floor Rack 42-44
- └ Tapes & Masking 45-47
- └ Mixing Cups & Liners 48-49
- └ Filters 50-52
- └ Spray Booth 53
- └ Dust Extraction 54-56
- └ Plastic Repair 57
- └ Dent Puller 58-61
- └ Spot Welder & MIG's 62-63
- └ Infrared & UVA LED Paint Curing Systems 64-67
- └ Tool Cabinets & Workbenches 68-71
- └ Solvent - Recyclers 72-75
- └ Solvent - Spray Gun & Pot Cleaners 76-78
- └ Waterborne - Recyclers, Waterborne - Spray Gun & Pot Cleaners 78-81
- └ Matrix Wand 82
- └ Wheel Aligner 83
- └ Bumper Sensor Kits 84-85
- └ Andreae 86
- └ Bossauto 87-88
- └ Etalon 89-91
- └ Fy-Tech 92-94
- └ Induction 95
- └ Meguro 96
- └ MWM 97
- └ Planit 98-101
- └ Stucchi 102
- └ Uniram 103-104

**Blind Rivet Gun**  
SKU: FY-KRS-505

Battery Powered, Pneumatic-Hydraulic Gun for Aluminium car body repair.

Pressure: 60KN  
Stroke: 30mm  
Cycle Time: 3 – 6s

Operation Method: Electric Hydraulic  
Various Optional Die and Head sets Available.



**Rotary Polishing Buff – PI-SRBV**  
SKU: PI-SRBV

240V 50Hz 1150W  
Speed: 1000-3500r/min  
Pad Size: 150mm  
Rotary M14



**Power Tools**

- 2 - 5 Abrasives & Cleaning
- 6 -10 Polishing
- 11-15 Air Tools
- 16-17 Compressors & Dryers
- 18-25 Power Tools
- 26-30 Hand Tools & Dollies
- 31-33 Pulling Clamps
- 34-37 Car Lifts & Dollies
- 38-41 Panel Stands & Parts Racks
- 42-44 Floor Rack
- 45-47 Tapes & Masking
- 48-49 Mixing Cups & Liners
- 50-52 Filters
- 53 Spray Booth
- 54-56 Dust Extraction
- 57 Plastic Repair
- 58-61 Dent Puller
- 62-63 Spot Welder & MIG's
- 64-67 Infrared & UVA LED Paint Curing Systems
- 68-71 Tool Cabinets & Workbenches
- 72-75 Solvent - Recyclers
- 76-78 Solvent - Spray Gun & Pot Cleaners
- 78-81 Waterborne - Recyclers Waterborne - Spray Gun & Pot Cleaners
- 82 Matrix Wand
- 83 Wheel Aligner
- 84-85 Bumper Sensor Kits
- 86 Andreae
- 87-88 Bossauto
- 89-91 Etalon
- 92-94 Fy-Tech
- 95 Induction
- 96 Meguro
- 97 MWM
- 98-101 Planit
- 102 Stucchi
- 103-104 Uniram



**Inductor Pro-Max**  
SKU: IIPM-200FL

Offering so much more than simple precise Invisible Heat, the Inductor Pro-Max is the auto pro's new best friend, saving many hours in labor and adding positively to the bottom line!

Packaged for the heating needs of the auto body collision professional including ALL Pro-Max attachments AND a heavy duty cart.

Comes with the below attachments:

U-Series Concentrator® (IIU-411): instantly heats nuts, bolts and all types of hardware red-hot in seconds and removes body caulking, seam sealers and hail dents. Allows users to remove corroded hardware in seconds, and body caulking in minutes leaving a clean surface and spot welds intact.

U-Series Glass Blaster® (IIU-311): removes bonded glass, SMC panels, metal bond adhesives and spray-on bedliners; windshields can also be removed in less than 15 minutes, while spray-on bedliners in as little as a few hours

U-Series Fast-Off® Pad (IIU-211): removes stripes, vinyl graphics, body side moldings, sound pads, vapor barriers, stress relieving sheet metal repairs and more. Literally saves hours on labor plus the added bonus on solvent-free removal as adhesive remains on graphic.

Cart: Heavy duty cart.



Power Tools

- └ Abrasives & Cleaning 2 - 5
- └ Polishing 6 -10
- └ Air Tools 11-15
- └ Compressors & Dryers 16-17
- └ Power Tools 18-25
- └ Hand Tools & Dollies 26-30
- └ Pulling Clamps 31-33
- └ Car Lifts & Dollies 34-37
- └ Panel Stands & Parts Racks 38-41
- └ Floor Rack 42-44
- └ Tapes & Masking 45-47
- └ Mixing Cups & Liners 48-49
- └ Filters 50-52
- └ Spray Booth 53
- └ Dust Extraction 54-56
- └ Plastic Repair 57
- └ Dent Puller 58-61
- └ Spot Welder & MIG's 62-63
- └ Infrared & UVA LED Paint Curing Systems 64-67
- └ Tool Cabinets & Workbenches 68-71
- └ Solvent - Recyclers 72-75
- └ Solvent - Spray Gun & Pot Cleaners 76-78
- └ Waterborne - Recyclers, Waterborne - Spray Gun & Pot Cleaners 78-81
- └ Matrix Wand 82
- └ Wheel Aligner 83
- └ Bumper Sensor Kits 84-85
- └ Andreae 86
- └ Bossauto 87-88
- └ Etalon 89-91
- └ Fy-Tech 92-94
- └ Induction 95
- └ Meguro 96
- └ MWM 97
- └ Planit 98-101
- └ Stucchi 102
- └ Uniram 103-104



**Inductor Rosebud Attachment**  
SKU: IIU-511

The Rosebud Attachment is an accessory for the Inductor Pro-Max, that allows you to quickly and safely salvage parts and remove decals bonded to aluminum, metal and glass without damaging nearby plastics.

Aluminum: stress relieving, annealing, vinyl graphic removal, and adhesive removal  
Steel: stress relieving, removing metal bond adhesives and fabricating.



**PDR Baton Attachment**  
Small SKU: IIU-111

Unlike traditional PDR, the Invisible Heat method is the cleanest and fastest way for fixing hail dents, door dings and other minor soft dents. There is no need to meticulously massage out from the backside of vehicle panels, especially in hard-to-reach areas, or areas difficult to get behind. Induction heating is the highest tech method for removing soft dents.



**Inductor Lite Glass Blaster**  
SKU: IIIL-311

Quickly and easily remove glass windshields, rear windows, rear quarter lights, sunroofs, and more

The Glass Blaster for the Inductor Lite is activated either by the button switch on the attachment or by pressing the pneumatic foot-pedal. The first switch which is activated has priority. The AUTO mode is particularly recommended for removing windows.



**Inductor Lite PDR Baton**  
SKU: IIIL-111

The Inductor Lite PDR Baton fixes hail dents, door dings and other minor soft dents, and can be activated by a switch on the attachment instead of the foot pedal.

Power Tools

- 2 - 5 Abrasives & Cleaning
- 6 -10 Polishing
- 11-15 Air Tools
- 16-17 Compressors & Dryers
- 18-25 Power Tools
- 26-30 Hand Tools & Dollies
- 31-33 Pulling Clamps
- 34-37 Car Lifts & Dollies
- 38-41 Panel Stands & Parts Racks
- 42-44 Floor Rack
- 45-47 Tapes & Masking
- 48-49 Mixing Cups & Liners
- 50-52 Filters
- 53 Spray Booth
- 54-56 Dust Extraction
- 57 Plastic Repair
- 58-61 Dent Puller
- 62-63 Spot Welder & MIG's
- 64-67 Infrared & UVA LED Paint Curing Systems
- 68-71 Tool Cabinets & Workbenches
- 72-75 Solvent - Recyclers
- 76-78 Solvent - Spray Gun & Pot Cleaners
- 78-81 Waterborne - Recyclers Waterborne - Spray Gun & Pot Cleaners
- 82 Matrix Wand
- 83 Wheel Aligner
- 84-85 Bumper Sensor Kits
- 86 Andreae
- 87-88 Bossauto
- 89-91 Etalon
- 92-94 Fy-Tech
- 95 Induction
- 96 Meguro
- 97 MWM
- 98-101 Planit
- 102 Stucchi
- 103-104 Uniram



**Mini Ductor Attachment**  
SKU: IIU-555

The IIU-555 Ductor Attachment operates off of the Inductor Pro-Max high performance induction heating system and offers at least 40% more power than the Mini-Ductor.

The IIU-555 is useful for heating faster or larger ferrous hardware and components, including nuts, bolts, bearings / races, pins, gears, pulleys, O<sup>2</sup> sensors, and much more.

Ergonomic grenade style grip.  
Bright white LED illuminates your work surface.  
9-foot HF cable with 8-pin connector.  
Includes 3 basic coils, carrying case (19"W x 10 1/2"D x 5"H) and operating manual.



**L-Wedge Accessory (Heat Resistant)**  
SKU: IIL0810A

The L-Wedge Accessory can be used with the inductor Pro-Max and Inductor Lite to help remove windows and moulding by applying heat with the inductor and using the L-Wedge to gently pry apart the window or moulding from the car.



**Inductor Lite Kit with Cart**  
SKU: IIIL2000C

The Inductor Lite is a compact and powerful 2,400W induction heater with a digital interface for manual heat control. This model includes a cart.

Using high frequency magnetic fields, the Inductor Lite utilizes Invisible Heat® to easily remove parts bonded to metal, including adhesives, logos, side moldings, direct glazed windows, stone guard protection, sealers, mechanical parts, and dents.



**Power Tools**

└ Abrasives & Cleaning 2-5  
 └ Polishing 6-10  
 └ Air Tools 11-15  
 └ Compressors & Dryers 16-17  
**└ Power Tools 18-25**  
 └ Hand Tools & Dollies 26-30  
 └ Pulling Clamps 31-33  
 └ Car Lifts & Dollies 34-37  
 └ Panel Stands & Parts Racks 38-41  
 └ Floor Rack 42-44  
 └ Tapes & Masking 45-47  
 └ Mixing Cups & Liners 48-49  
 └ Filters 50-52  
 └ Spray Booth 53  
 └ Dust Extraction 54-56  
 └ Plastic Repair 57  
 └ Dent Puller 58-61  
 └ Spot Welder & MIG's 62-63  
 └ Infrared & UVA LED Paint Curing Systems 64-67  
 └ Tool Cabinets & Workbenches 68-71  
 └ Solvent - Recyclers 72-75  
 └ Solvent - Spray Gun & Pot Cleaners 76-78  
 └ Waterborne - Recyclers, Waterborne - Spray Gun & Pot Cleaners 78-81  
 └ Matrix Wand 82  
 └ Wheel Aligner 83  
 └ Bumper Sensor Kits 84-85  
 └ Andreae 86  
 └ Bossauto 87-88  
 └ Etalon 89-91  
 └ Fy-Tech 92-94  
 └ Induction 95  
 └ Meguro 96  
 └ MWM 97  
 └ Planit 98-101  
 └ Stucchi 102  
 └ Uniram 103-104



**Mini-Ductor Essential Coil Kit**  
SKU: IIMD99-660

Contains:  
 x1 3/4" pre-formed coil  
 x1 1/2" pre-formed coil  
 x1 1/4" pre-formed coil  
 x1 1" pre-formed coil  
 x2 7/8" pre-formed coils  
 x1 3/4" pre-formed coil  
 x1 7/8" long pre-formed coil



**Mini-Ductor Essential Coil Kit**  
SKU: IIMD99-660

Contains:  
 x1 - 1" Preformed Coil  
 x2 - 7/8" Preformed Coil  
 x2 - 3/4" Preformed Coil  
 x1 - 1" Long Preformed Coil  
 x1 - 7/8" Long Preformed Coil  
 x1 - 7/8" Long Preformed Coil



**Mini-Ductor Long Coil Kit**  
SKU: IIMD99-675

Contains:  
 x2 - 1" Preformed Coil  
 x2 - 7/8" Preformed Coil  
 x1 - 3/4" Long Preformed Coil  
 x1 - 1 3/4" Long Preformed Coil  
 x1 - 1 1/2" Long Preformed Coil  
 x1 - 1 3/4" Long Preformed Coil

Use of the proper size coil, avoiding abrasion and overheating prevents premature wear to the coil. All coils are coated to eliminate oxidation and guarantee contact. The coil insulation is coated to resist abrasion – however, if insulation is breached, a new coil will need to be used. The coils are all flexible and can be bent or separated for a variety of applications.



**Mini-Ductor II**  
SKU: IIMD800P

The Mini-Ductor II releases metal from corrosion and thread lock compounds without the dangers of open flame, and is up to 90% faster than an oxy-acetylene torch.

Comes with:  
 Mini-Ductor II+  
 Carrying Case  
 Coil Variety Pack – IIMD99-60123 (Pack Includes: 7/8" Pre-formed Coil, U-form Coil and Bearing Buddy Coil)  
 And an instructional DVD.



**Mini-Ductor Variety Coil Pack**  
SKU: IIMD99-60123

Contains:  
 x1 - U-Form Coil  
 x1 - Bearing Buddy Coil  
 x1 - 7/8" Preformed Coil



**Power Tools**

2-5 Abrasives & Cleaning  
 6-10 Polishing  
 11-15 Air Tools  
 16-17 Compressors & Dryers  
**18-25 Power Tools**  
 26-30 Hand Tools & Dollies  
 31-33 Pulling Clamps  
 34-37 Car Lifts & Dollies  
 38-41 Panel Stands & Parts Racks  
 42-44 Floor Rack  
 45-47 Tapes & Masking  
 48-49 Mixing Cups & Liners  
 50-52 Filters  
 53 Spray Booth  
 54-56 Dust Extraction  
 57 Plastic Repair  
 58-61 Dent Puller  
 62-63 Spot Welder & MIG's  
 64-67 Infrared & UVA LED Paint Curing Systems  
 68-71 Tool Cabinets & Workbenches  
 72-75 Solvent - Recyclers  
 76-78 Solvent - Spray Gun & Pot Cleaners  
 78-81 Waterborne - Recyclers Waterborne - Spray Gun & Pot Cleaners  
 82 Matrix Wand  
 83 Wheel Aligner  
 84-85 Bumper Sensor Kits  
 86 Andreae  
 87-88 Bossauto  
 89-91 Etalon  
 92-94 Fy-Tech  
 95 Induction  
 96 Meguro  
 97 MWM  
 98-101 Planit  
 102 Stucchi  
 103-104 Uniram



**Mini Ductor Venom**  
SKU: IIMDV-888



The Newly Designed Mini-Ductor Venom Induction Heater Has Real Bite. The Mini-Ductor Venom generates Invisible Heat to release ferrous and some non-ferrous metals from corrosion and thread lock compounds without the dangers of open flame and up to 90% faster 3/4" nuts are turned red hot in seconds.

**Venom also includes the following enhancements over the Mini-Ductor II:**  
**Angled Design with Trigger:** Venom's lightweight, ergonomic design allows for induction heat to access hard to reach places more easily.  
**Coil Twist Lock:** coils now lock down with one simple turn. (no more thumb screws)  
**LED Usage Indicator:** a red LED will light under faulty conditions and green LED lights while the trigger is active and the tool is heating properly.  
**Fault Override Delay:** any event that causes the red LED to illuminate will protect the tool by starting a three-second lock out.  
**Fan Operation Enhancements:** the fan continues to run after the trigger is released to aid in thermal cycle time reduction, and will stay powered when the thermal switch opens to aid in cooling the tool.  
**User Controlled LED Switch:** as long as the tool is powered and the internal power supply is operating, the LED will remain lit when the switch is on.



Hand Tools & Dollys

- └ Abrasives & Cleaning 2-5
- └ Polishing 6-10
- └ Air Tools 11-15
- └ Compressors & Dryers 16-17
- └ Power Tools 18-25
- └ **Hand Tools & Dollys 26-30**
- └ Pulling Clamps 31-33
- └ Car Lifts & Dollys 34-37
- └ Panel Stands & Parts Racks 38-41
- └ Floor Rack 42-44
- └ Tapes & Masking 45-47
- └ Mixing Cups & Liners 48-49
- └ Filters 50-52
- └ Spray Booth 53
- └ Dust Extraction 54-56
- └ Plastic Repair 57
- └ Dent Puller 58-61
- └ Spot Welder & MIG's 62-63
- └ Infrared & UVA LED Paint Curing Systems 64-67
- └ Tool Cabinets & Workbenches 68-71
- └ Solvent - Recyclers 72-75
- └ Solvent - Spray Gun & Pot Cleaners 76-78
- └ Waterborne - Recyclers, Waterborne - Spray Gun & Pot Cleaners 78-81
- └ Matrix Wand 82
- └ Wheel Aligner 83
- └ Bumper Sensor Kits 84-85
- └ Andreae 86
- └ Bossauto 87-88
- └ Etalon 89-91
- └ Fy-Tech 92-94
- └ Induction 95
- └ Meguro 96
- └ MWM 97
- └ Planit 98-101
- └ Stucchi 102
- └ Uniram 103-104



**Panel Beating Hammer Dolly Kit 6pcs**  
SKU: PI071-006

Contains 6 Pieces:  
Shrinking Hammer, Pick & Finish Hammer  
Universal Dolly, Curved Dolly, Toe Dolly,  
Drip Moulding Spoon.



**13 Piece Auto Body Repair Set Heavy Duty Dent Puller**  
SKU: BLP072-022

Coming in a heavy duty blow molded case for easy storage and transportation.  
The 13 Piece Auto Body Repair Set Heavy Duty Dent Puller was designed to remove dents from bodywork.

10lb malleable steel slide hammer. With a solid steel shaft and knurled handle for sure grip.  
Drop forged and heat treated steel hooks, pullers and attachments.

Hand Tools & Dollys

- 2-5 Abrasives & Cleaning
- 6-10 Polishing
- 11-15 Air Tools
- 16-17 Compressors & Dryers
- 18-25 Power Tools
- 26-30 **Hand Tools & Dollys**
- 31-33 Pulling Clamps
- 34-37 Car Lifts & Dollys
- 38-41 Panel Stands & Parts Racks
- 42-44 Floor Rack
- 45-47 Tapes & Masking
- 48-49 Mixing Cups & Liners
- 50-52 Filters
- 53 Spray Booth
- 54-56 Dust Extraction
- 57 Plastic Repair
- 58-61 Dent Puller
- 62-63 Spot Welder & MIG's
- 64-67 Infrared & UVA LED Paint Curing Systems
- 68-71 Tool Cabinets & Workbenches
- 72-75 Solvent - Recyclers
- 76-78 Solvent - Spray Gun & Pot Cleaners
- 78-81 Waterborne - Recyclers Waterborne - Spray Gun & Pot Cleaners
- 82 Matrix Wand
- 83 Wheel Aligner
- 84-85 Bumper Sensor Kits
- 86 Andreae
- 87-88 Bossauto
- 89-91 Etalon
- 92-94 Fy-Tech
- 95 Induction
- 96 Meguro
- 97 MWM
- 98-101 Planit
- 102 Stucchi
- 103-104 Uniram



**Suction Gun (1.7mm Tip)**  
SKU: PICO128-054

Air Consumption: 14cfm  
Cup Size: 1000ml  
Fluid(water) Delivery:  
120-180ml/min  
Air Pressure: 50psi  
Air Inlet: G1/4

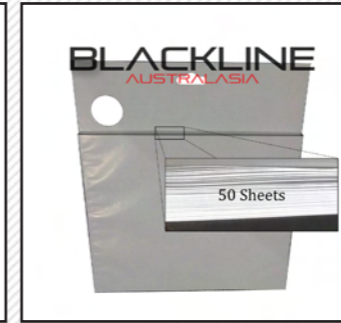

**Onion Board**  
SKU: PLOB

The perfect solution for mixing filler on as it provides a cheap, clean, non porous & disposable surface to prepare on.  
Size: 21 x 27cm  
50 Sheets



**PDR Line Board**  
SKU: PILBL

The PDR Line Board dent removal tool will assist in spotting and fixing dents on painted panels.



**10 Step Drill Bit**  
SKU: BLP722-0422M

10 Step Drill Bit can drill holes from 4mm up to 22mm

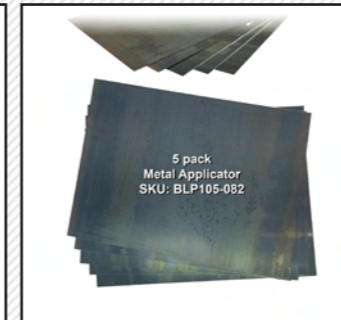

**5 Pack Metal Applicator**  
SKU: BLP105-082

Pack of 5 metal applicator pads



**Bonnet Holder Telescopic**  
SKU: BLP557-001

Min Length: 54cm  
Max Length: 120cm  
Can be used to prop open bonnets, doors and pannels.



**Door Pin Extractor**  
SKU: BLP014-095

Comes with 3 pin sizes to extract most door and hinge pins.



Hand Tools & Dollys

- └ Abrasives & Cleaning 2-5
- └ Polishing 6-10
- └ Air Tools 11-15
- └ Compressors & Dryers 16-17
- └ Power Tools 18-25
- └ **Hand Tools & Dollys 26-30**
- └ Pulling Clamps 31-33
- └ Car Lifts & Dollys 34-37
- └ Panel Stands & Parts Racks 38-41
- └ Floor Rack 42-44
- └ Tapes & Masking 45-47
- └ Mixing Cups & Liners 48-49
- └ Filters 50-52
- └ Spray Booth 53
- └ Dust Extraction 54-56
- └ Plastic Repair 57
- └ Dent Puller 58-61
- └ Spot Welder & MIG's 62-63
- └ Infrared & UVA LED Paint Curing Systems 64-67
- └ Tool Cabinets & Workbenches 68-71
- └ Solvent - Recyclers 72-75
- └ Solvent - Spray Gun & Pot Cleaners 76-78
- └ Waterborne - Recyclers, Waterborne - Spray Gun & Pot Cleaners 78-81
- └ Matrix Wand 82
- └ Wheel Aligner 83
- └ Bumper Sensor Kits 84-85
- └ Andreae 86
- └ Bossauto 87-88
- └ Etalon 89-91
- └ Fy-Tech 92-94
- └ Induction 95
- └ Meguro 96
- └ MWM 97
- └ Planit 98-101
- └ Stucchi 102
- └ Uniram 103-104



**Vacuum Sanding Kit**  
SKU: PISBK5PC

Use Vacuum Sanding Kit with Hook and Loop Sanding papers.

Comes in a hard case.



**12lb Slide Hammer Set**  
SKU: BLP072-021

For those hard-to-get-at places on unit-sized body reconstruction, when working on fenders, rocker panels, door edges, bumper ends, aligning doors, hoods, trunks, etc. Hammers both ways without reversing. solid 5/8" steel slide shaft, pipe end nose adapter is machined and plated.

Comes with:  
 1pc Screw, 1pc Adapter,  
 1pc Door Edge Tool, 1pc Nose Piece,  
 1pc Straight Driver, 1pc Hammer and Shaft,  
 1pc Short Hook, 1pc Claw,  
 1pc Deep Hook, 1pc Hook and Chain.



Hand Tools & Dollys

- └ Abrasives & Cleaning 2-5
- └ Polishing 6-10
- └ Air Tools 11-15
- └ Compressors & Dryers 16-17
- └ Power Tools 18-25
- └ **Hand Tools & Dollys 26-30**
- └ Pulling Clamps 31-33
- └ Car Lifts & Dollys 34-37
- └ Panel Stands & Parts Racks 38-41
- └ Floor Rack 42-44
- └ Tapes & Masking 45-47
- └ Mixing Cups & Liners 48-49
- └ Filters 50-52
- └ Spray Booth 53
- └ Dust Extraction 54-56
- └ Plastic Repair 57
- └ Dent Puller 58-61
- └ Spot Welder & MIG's 62-63
- └ Infrared & UVA LED Paint Curing Systems 64-67
- └ Tool Cabinets & Workbenches 68-71
- └ Solvent - Recyclers 72-75
- └ Solvent - Spray Gun & Pot Cleaners 76-78
- └ Waterborne - Recyclers Waterborne - Spray Gun & Pot Cleaners 78-81
- └ Matrix Wand 82
- └ Wheel Aligner 83
- └ Bumper Sensor Kits 84-85
- └ Andreae 86
- └ Bossauto 87-88
- └ Etalon 89-91
- └ Fy-Tech 92-94
- └ Induction 95
- └ Meguro 96
- └ MWM 97
- └ Planit 98-101
- └ Stucchi 102
- └ Uniram 103-104

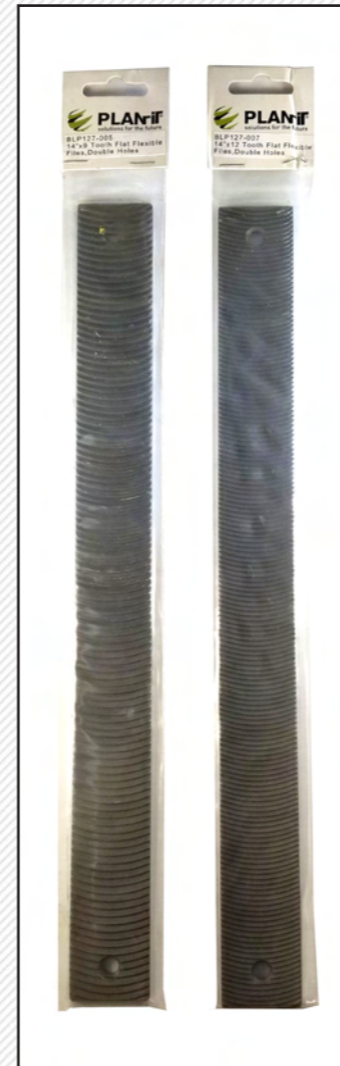

**Flat Flexible File with Holes**

**9 Tooth File**  
SKU: BLP127-005

**14 Tooth File**  
SKU: BLP127-007

For use on its own or attached to the Abrasive File Holder below.



**Flexible Velcro Hand Block**  
SKU: ETVHB70400PL

70 x 400mm  
 Velcro system flexible hand block for abrasive strips, ideal for sanding of large surfaces, slightly curved.



**Multi Dolly Big**  
SKU: BLP23499

Slightly larger than the small multi dolly.  
 Has 5 different shaping surfaces.



**Multi Dolly Small**  
SKU: BLP13062

Good for tight spaces and has 5 different shaping surfaces.



**Slapping File Coarse**  
SKU: BLP127-002

Used to shrink stretched metal and highlight low spots.  
 An old-time secret for removing dents and/or smoothing body work on hand fabricated panels. The serrated face works in two ways:  
 Shrinks the stretched metal. Highlights high/low spots that require hammer and dolly work.



**File Sander Adjustable**  
SKU: BLP125-009

For use with Abrasive Files.



**Seam Buster**  
SKU: BLP239 021

Made from super tough alloy steel the seam buster is sharpened on two edges and has a cushioned handle for shock absorption.

The sharp end allows for penetration between the panels and the side edge allows for side impact to drive the panels apart without damage.





Hand Tools & Dollys

- └ Abrasives & Cleaning 2-5
- └ Polishing 6-10
- └ Air Tools 11-15
- └ Compressors & Dryers 16-17
- └ Power Tools 18-25
- └ Hand Tools & Dollys 26-30
- └ Pulling Clamps 31-33
- └ Car Lifts & Dollys 34-37
- └ Panel Stands & Parts Racks 38-41
- └ Floor Rack 42-44
- └ Tapes & Masking 45-47
- └ Mixing Cups & Liners 48-49
- └ Filters 50-52
- └ Spray Booth 53
- └ Dust Extraction 54-56
- └ Plastic Repair 57
- └ Dent Puller 58-61
- └ Spot Welder & MIG's 62-63
- └ Infrared & UVA LED Paint Curing Systems 64-67
- └ Tool Cabinets & Workbenches 68-71
- └ Solvent - Recyclers 72-75
- └ Solvent - Spray Gun & Pot Cleaners 76-78
- └ Waterborne - Recyclers, Waterborne - Spray Gun & Pot Cleaners 78-81
- └ Matrix Wand 82
- └ Wheel Aligner 83
- └ Bumper Sensor Kits 84-85
- └ Andreae 86
- └ Bossauto 87-88
- └ Etalon 89-91
- └ Fy-Tech 92-94
- └ Induction 95
- └ Meguro 96
- └ MWM 97
- └ Planit 98-101
- └ Stucchi 102
- └ Uniram 103-104



**8mm Cobalt Spot Weld Drill Bit**  
SKU: BOS050081

Cobalt spot weld drill bit for drilling work.  
Ø 8 mm, long.



**8mm Cobalt-Titanium Spot Weld Drill Bit**  
SKU: BOS050085

Cobalt and titanium spot weld drill bit for working with spot weld drill. Ø 8 mm, short.



**THIN TOE DOLLY**  
SKU: BLP071-003



**DOLLY ANVIL**  
SKU: BLP071-026



**FLAT SPOON DOLLY**  
SKU: BLP071-033



**DOUBLE SPOON**  
SKU: BLP071-031



Pulling Clamps

- └ Abrasives & Cleaning 2-5
- └ Polishing 6-10
- └ Air Tools 11-15
- └ Compressors & Dryers 16-17
- └ Power Tools 18-25
- └ Hand Tools & Dollys 26-30
- └ Pulling Clamps 31-33
- └ Car Lifts & Dollys 34-37
- └ Panel Stands & Parts Racks 38-41
- └ Floor Rack 42-44
- └ Tapes & Masking 45-47
- └ Mixing Cups & Liners 48-49
- └ Filters 50-52
- └ Spray Booth 53
- └ Dust Extraction 54-56
- └ Plastic Repair 57
- └ Dent Puller 58-61
- └ Spot Welder & MIG's 62-63
- └ Infrared & UVA LED Paint Curing Systems 64-67
- └ Tool Cabinets & Workbenches 68-71
- └ Solvent - Recyclers 72-75
- └ Solvent - Spray Gun & Pot Cleaners 76-78
- └ Waterborne - Recyclers, Waterborne - Spray Gun & Pot Cleaners 78-81
- └ Matrix Wand 82
- └ Wheel Aligner 83
- └ Bumper Sensor Kits 84-85
- └ Andreae 86
- └ Bossauto 87-88
- └ Etalon 89-91
- └ Fy-Tech 92-94
- └ Induction 95
- └ Meguro 96
- └ MWM 97
- └ Planit 98-101
- └ Stucchi 102
- └ Uniram 103-104



**Big Mouth Clamp**  
SKU: TJGD4-102

Capacity: 3ton  
One-way pull operation.  
Same sizes for two jaws.



**Large Pull Clamp (with top pull)**  
SKU: TJGD4-102N

Different sizes for two jaws  
Two-way pull operation  
Capacity: 3ton on straight way  
2ton on cross way



**Grab Hook Plate**  
SKU: BLP5753

For attaching chain to floor rack.



**Chain Joint (Double Claw Hooks)**  
SKU: TJGD4-203

Capacity: 6 Ton  
For use as chain shortener or chain connector.  
Use with 5/16" or 3/8" chains.  
Contact of tow chain is always on a same level, meaning no twisting of Chain happens accordingly



**Chain Joint (Double Grab Hooks)**  
SKU: TJGD4-204

Capacity: 6ton  
For use as chain shortner or chain connector.  
Use with 5/16" or 3/8" Chains.  
Useful as a fitting of tow chains or a chain and a hook.



**Chain Joint (for two clamp)**  
SKU: TJGD4-202

Capacity: 6ton  
Use with 5/16" or 3/8" chains.  
For use with pulling tow clamp.



**Heavy Duty Pull Clamp**  
SKU: TJGD4-103

Capacity: 5ton  
One-way pull operation  
For heavy duty use.



**Long Nose Clamp**  
SKU: TJGD4-105

Capacity: 2ton  
One-way pull operation  
Long nose for use in narrow space.



**Multi Hole Pull Plate**  
SKU: BLP215-035

High grade (Cr-Mo) alloy steel for maximum strength.  
Can be easily bolted in multiple positions on vehicle and used to pull in straight lines.  
Suitable for use with body shop repair kits and chassis straighteners.



**Pulling Clamps**

- └ Abrasives & Cleaning 2-5
- └ Polishing 6-10
- └ Air Tools 11-15
- └ Compressors & Dryers 16-17
- └ Power Tools 18-25
- └ Hand Tools & Dollys 26-30
- └ **Pulling Clamps 31-33**
- └ Car Lifts & Dollys 34-37
- └ Panel Stands & Parts Racks 38-41
- └ Floor Rack 42-44
- └ Tapes & Masking 45-47
- └ Mixing Cups & Liners 48-49
- └ Filters 50-52
- └ Spray Booth 53
- └ Dust Extraction 54-56
- └ Plastic Repair 57
- └ Dent Puller 58-61
- └ Spot Welder & MIG's 62-63
- └ Infrared & UVA LED Paint Curing Systems 64-67
- └ Tool Cabinets & Workbenches 68-71
- └ Solvent - Recyclers 72-75
- └ Solvent - Spray Gun & Pot Cleaners 76-78
- └ Waterborne - Recyclers, Waterborne - Spray Gun & Pot Cleaners 78-81
- └ Matrix Wand 82
- └ Wheel Aligner 83
- └ Bumper Sensor Kits 84-85
- └ Andreae 86
- └ Bossauto 87-88
- └ Etalon 89-91
- └ Fy-Tech 92-94
- └ Induction 95
- └ Meguro 96
- └ MWM 97
- └ Planit 98-101
- └ Stucchi 102
- └ Uniram 103-104



**Frame Rack Clamp (two way)**  
SKU: TJGD4-601N

Capacity: 5 Ton on straight  
3 Ton on cross  
Two-way pull operation  
Serrate Width: 120mm  
The wide plate makes the clamp more durable and strong



**Mini Pull Clamp (two way)**  
SKU: TJGD4-104

Capacity: 3ton on straight way  
2ton on cross way  
Two-way pull operation  
Mini size for use in small spaces.



**Scissors Clamp**  
SKU: TJGD4-106

Capacity: 3 ton  
Single-way pull operation



**Tight Opening Clamp**  
SKU: BLP019-055

FMade from high grade alloy steel for maximum strength. The Tight Opening Clamp is able to reach core support and upper sheet metal areas. Ideal for small pick-up frame rails.

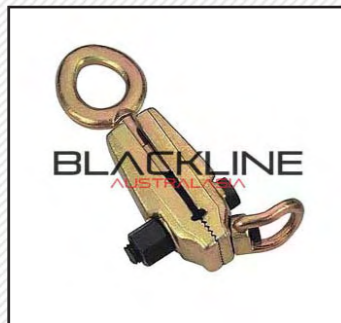

**Small Mouth Pull Clamp**  
SKU: TJGD4-101N

Capacity: 5ton.  
Two-way pull operation.  
44mm wide mouth with teeth  
With top pull and 360 degree self tightening pull ring.  
Ideal for work in tight areas.



**Small Mouth Pull Clamp**  
SKU: TJGD4-101

Capacity: 5ton.  
One-way pull operation.



**Pulling Pot**  
SKU: BLPPOT

Cast Iron  
Can rotate 360 °

**Pulling Clamps**

- └ Abrasives & Cleaning 2-5
- └ Polishing 6-10
- └ Air Tools 11-15
- └ Compressors & Dryers 16-17
- └ Power Tools 18-25
- └ Hand Tools & Dollys 26-30
- └ **Pulling Clamps 31-33**
- └ Car Lifts & Dollys 34-37
- └ Panel Stands & Parts Racks 38-41
- └ Floor Rack 42-44
- └ Tapes & Masking 45-47
- └ Mixing Cups & Liners 48-49
- └ Filters 50-52
- └ Spray Booth 53
- └ Dust Extraction 54-56
- └ Plastic Repair 57
- └ Dent Puller 58-61
- └ Spot Welder & MIG's 62-63
- └ Infrared & UVA LED Paint Curing Systems 64-67
- └ Tool Cabinets & Workbenches 68-71
- └ Solvent - Recyclers 72-75
- └ Solvent - Spray Gun & Pot Cleaners 76-78
- └ Waterborne - Recyclers Waterborne - Spray Gun & Pot Cleaners 78-81
- └ Matrix Wand 82
- └ Wheel Aligner 83
- └ Bumper Sensor Kits 84-85
- └ Andreae 86
- └ Bossauto 87-88
- └ Etalon 89-91
- └ Fy-Tech 92-94
- └ Induction 95
- └ Meguro 96
- └ MWM 97
- └ Planit 98-101
- └ Stucchi 102
- └ Uniram 103-104



**Pull Clamp**  
SKU: TJGD4-031

Capacity: 6ton on straight way.  
One-way pull operation.  
Serrated teeth width: 100mm  
You can make a straight 6 angle pull with this clamp.  
Replaceable hardened steel jaws come as standard.



**Right Angle Clamp & Yoke**  
SKU: TJGD4-032

Capacity: 6ton on straight way  
3 ton on cross way.  
Two-way pull operation.  
Serrated width: 100mm  
Replaceable hardened steel jaws come as standard.



**Multi Directional Pull Clamp**  
SKU: TJGD4-011

Capacity: 6ton  
100mm Deep Jaw, Self Packing Clamp.



**Large Hook Pulling Kit**  
SKU: TJGD4121

Capacity: 6ton  
Supplied with 2 sizes of feet.  
Ideal for inside boot recesses.  
Suitable for reaching over wide obstructions.



**Pull Clamp**  
SKU: TJGD4-035

Capacity: 6 Ton  
100mm Deep Jaw, Self Packing Clamp.



**Pull Clamp**  
SKU: TJGD4-010

Capacity: 6T  
60mm Deep Jaw, Self Packing Clamp.



## Car Lifts & Dollies

- └ Abrasives & Cleaning 2 - 5
- └ Polishing 6 -10
- └ Air Tools 11-15
- └ Compressors & Dryers 16-17
- └ Power Tools 18-25
- └ Hand Tools & Dollies 26-30
- └ Pulling Clamps 31-33
- └ **Car Lifts & Dollies 34-37**
- └ Panel Stands & Parts Racks 38-41
- └ Floor Rack 42-44
- └ Tapes & Masking 45-47
- └ Mixing Cups & Liners 48-49
- └ Filters 50-52
- └ Spray Booth 53
- └ Dust Extraction 54-56
- └ Plastic Repair 57
- └ Dent Puller 58-61
- └ Spot Welder & MIG's 62-63
- └ Infrared & UVA LED Paint Curing Systems 64-67
- └ Tool Cabinets & Workbenches 68-71
- └ Solvent - Recyclers 72-75
- └ Solvent - Spray Gun & Pot Cleaners 76-78
- └ Waterborne - Recyclers, Waterborne - Spray Gun & Pot Cleaners 78-81
- └ Matrix Wand 82
- └ Wheel Aligner 83
- └ Bumper Sensor Kits 84-85
- └ Andreae 86
- └ Bossauto 87-88
- └ Etalon 89-91
- └ Fy-Tech 92-94
- └ Induction 95
- └ Meguro 96
- └ MWM 97
- └ Planit 98-101
- └ Stucchi 102
- └ Uniram 103-104



**Astra Power Lift**  
SKU: AE500R

Mid-rise scissor lift  
Super-slim (only 10cm) simply drive the car over the lift. It can also be flush mounted in floor.  
New lifting supports with height regulation thread.  
High quality and 3.000 kg capacity (4.200 kg CE tested).  
Max lift height: 1m



**Low Vehicle Ramps**  
SKU: AE106

These heavy duty rubber ramps are an accessory for the Astra miniLift and miniLiftLow. Can be used to raise extremely low vehicles.  
Size: 71 x 26 x 16cm  
Weight: 17kg



**Safety Trestle Set**  
SKU: AE102

Jack Stands

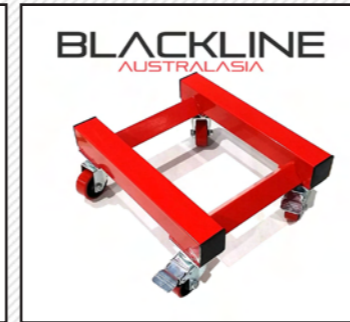

**1250LB Car Dolly Set**  
SKU: BLPMCSET

Comes with 2 Dollies.



**Lift and Move Kit**  
SKU: AE104



## Car Lifts & Dollies

- └ Abrasives & Cleaning 2 - 5
- └ Polishing 6 -10
- └ Air Tools 11-15
- └ Compressors & Dryers 16-17
- └ Power Tools 18-25
- └ Hand Tools & Dollies 26-30
- └ Pulling Clamps 31-33
- └ **Car Lifts & Dollies 34-37**
- └ Panel Stands & Parts Racks 38-41
- └ Floor Rack 42-44
- └ Tapes & Masking 45-47
- └ Mixing Cups & Liners 48-49
- └ Filters 50-52
- └ Spray Booth 53
- └ Dust Extraction 54-56
- └ Plastic Repair 57
- └ Dent Puller 58-61
- └ Spot Welder & MIG's 62-63
- └ Infrared & UVA LED Paint Curing Systems 64-67
- └ Tool Cabinets & Workbenches 68-71
- └ Solvent - Recyclers 72-75
- └ Solvent - Spray Gun & Pot Cleaners 76-78
- └ Waterborne - Recyclers, Waterborne - Spray Gun & Pot Cleaners 78-81
- └ Matrix Wand 82
- └ Wheel Aligner 83
- └ Bumper Sensor Kits 84-85
- └ Andreae 86
- └ Bossauto 87-88
- └ Etalon 89-91
- └ Fy-Tech 92-94
- └ Induction 95
- └ Meguro 96
- └ MWM 97
- └ Planit 98-101
- └ Stucchi 102
- └ Uniram 103-104



**Mini Lift - Classic**  
SKU: AE1001

The original system of compact and fast lifting for the automotive market.

MiniLIFT enables you to work at the right height for: Bodyshops, Garages and Tyres-shops. With its small size, you can easily place the lift under the car and then work in the same way as any other lift. Extremely versatile lift, which allows you to lift any small/large car, van and SUV on the market.

MiniLift, gives you the ability to move the car through the shop on the lift, thanks to the option of having wheels. The maximum lifting height of the car's axis is one meter sixty centimeters, which allows you to carry out 90% of all existing services: oil change, replacement of brake pads, grooving of brake discs, replacement of shock absorbers and running gear parts, and so on. And a large lifting capacity will lift almost any car with a mass of up to 5 tons.

Maximum height from the ground (one axis): 1600mm  
Maximum height from the ground (two axes): 550mm  
Carrying capacity (two axles): 2500kg  
Carrying capacity (one axle): 4500kg  
Minimum height from ground: 113mm

The maximum length is: 1832mm  
The minimum length is: 1115mm  
Weight: 105kg  
Working pressure of pneumatic: 6-8 bar  
Lifting speed to maximum height: 13 Seconds



**Minilift Adapter Kit BMW & AUDI**  
SKU: AE105

Allows lifting of BMW, AUDI & other vehicles without door seals.

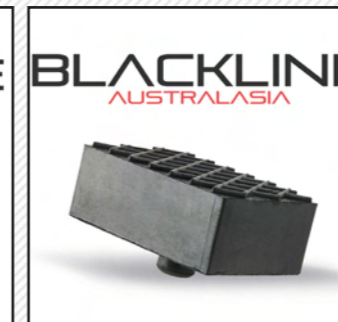

**Minilift Taco for Lateral Lifting**  
SKU: SP0227

Minilift Taco for Lateral Lifting allows the miniLift to be used like a regular jack to lift from a single point.

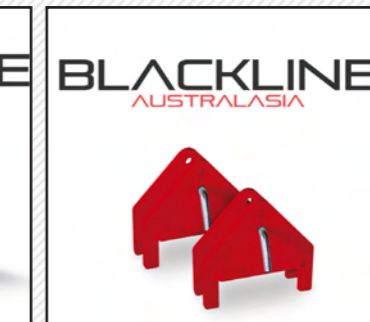

**Minilift Adapter Kit for Vans and 4x4's**  
SKU: AE103

Special addaptor for lifting Vans and 4x4



Car Lifts & Dollies

- └ Abrasives & Cleaning 2 - 5
- └ Polishing 6 -10
- └ Air Tools 11-15
- └ Compressors & Dryers 16-17
- └ Power Tools 18-25
- └ Hand Tools & Dollies 26-30
- └ Pulling Clamps 31-33
- └ **Car Lifts & Dollies 34-37**
- └ Panel Stands & Parts Racks 38-41
- └ Floor Rack 42-44
- └ Tapes & Masking 45-47
- └ Mixing Cups & Liners 48-49
- └ Filters 50-52
- └ Spray Booth 53
- └ Dust Extraction 54-56
- └ Plastic Repair 57
- └ Dent Puller 58-61
- └ Spot Welder & MIG's 62-63
- └ Infrared & UVA LED Paint Curing Systems 64-67
- └ Tool Cabinets & Workbenches 68-71
- └ Solvent - Recyclers 72-75
- └ Solvent - Spray Gun & Pot Cleaners 76-78
- └ Waterborne - Recyclers, Waterborne - Spray Gun & Pot Cleaners 78-81
- └ Matrix Wand 82
- └ Wheel Aligner 83
- └ Bumper Sensor Kits 84-85
- └ Andreae 86
- └ Bossauto 87-88
- └ Etalon 89-91
- └ Fy-Tech 92-94
- └ Induction 95
- └ Meguro 96
- └ MWM 97
- └ Planit 98-101
- └ Stucchi 102
- └ Uniram 103-104



**Astra Mini Lift Low**  
SKU: AE100L

Compact mobile lift with lift&move system

- Designed for professionals: bodyshops, mechanicals, tyreshops and fast services
- Exclusive design with folding handle for a clear working area
- Optional wheel kit (AE104) to enable movement of the lift and vehicle together

MAXIMUM ADMITTED LOAD: 2,200kg  
 MAXIMUM HEIGHT FROM THE GROUND: 550mm  
 MINIMUM HEIGHT FROM THE GROUND: 123mm  
 MAXIMUM WIDTH: 634mm  
 MINIMUM LENGTH: 1.630mm  
 MAXIMUM LENGTH: 2.180mm  
 STRUCTURE WEIGHT WITH ACCESSORIES: 160kg  
 PNEUMATIC PRESSURE CIRCUIT: 6 – 8bar  
 ASCENT TIME: 13seconds  
 DESCENT TIME: 17seconds  
 Comes with a pair of Safety Stands and Dolly Wheels.



**MiniliftLow Adapters Vans**  
4x4  
SKU: AE103L1

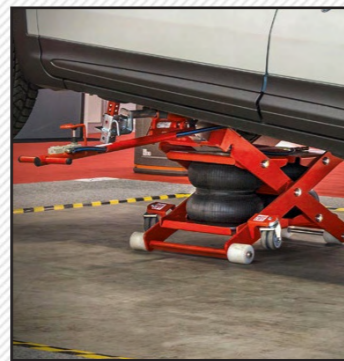

Adapter for mounting Vans and 4x4's



**MiniliftLow Adapters for BMW, AUDI**  
SKU: AE105L

Addapter for Audi and BMW lifting.



Car Lifts & Dollies

- 2 - 5 Abrasives & Cleaning
- 6 -10 Polishing
- 11-15 Air Tools
- 16-17 Compressors & Dryers
- 18-25 Power Tools
- 26-30 Hand Tools & Dollies
- 31-33 Pulling Clamps
- 34-37 **Car Lifts & Dollies**
- 38-41 Panel Stands & Parts Racks
- 42-44 Floor Rack
- 45-47 Tapes & Masking
- 48-49 Mixing Cups & Liners
- 50-52 Filters
- 53 Spray Booth
- 54-56 Dust Extraction
- 57 Plastic Repair
- 58-61 Dent Puller
- 62-63 Spot Welder & MIG's
- 64-67 Infrared & UVA LED Paint Curing Systems
- 68-71 Tool Cabinets & Workbenches
- 72-75 Solvent - Recyclers
- 76-78 Solvent - Spray Gun & Pot Cleaners
- 78-81 Waterborne - Recyclers Waterborne - Spray Gun & Pot Cleaners
- 82 Matrix Wand
- 83 Wheel Aligner
- 84-85 Bumper Sensor Kits
- 86 Andreae
- 87-88 Bossauto
- 89-91 Etalon
- 92-94 Fy-Tech
- 95 Induction
- 96 Meguro
- 97 MWM
- 98-101 Planit
- 102 Stucchi
- 103-104 Uniram



**Astra Mini Bench**  
SKU: AB5300

The Astra Mini Bench is a compact lift with 3,000kg of lifting capacity with 8 tonne pulling tower, for medium repairs.

The pulling tower can be placed around the bench at 360 degrees and 180 degrees on itself, to better focus the right pulling direction.

Its dimensions of only 235cm length is ideal for bodyshops with a lack of space. Moreover its easier to fit lower cars.

Various Additional Pads, Adaptors, Extenders and Stands are also available upon request.

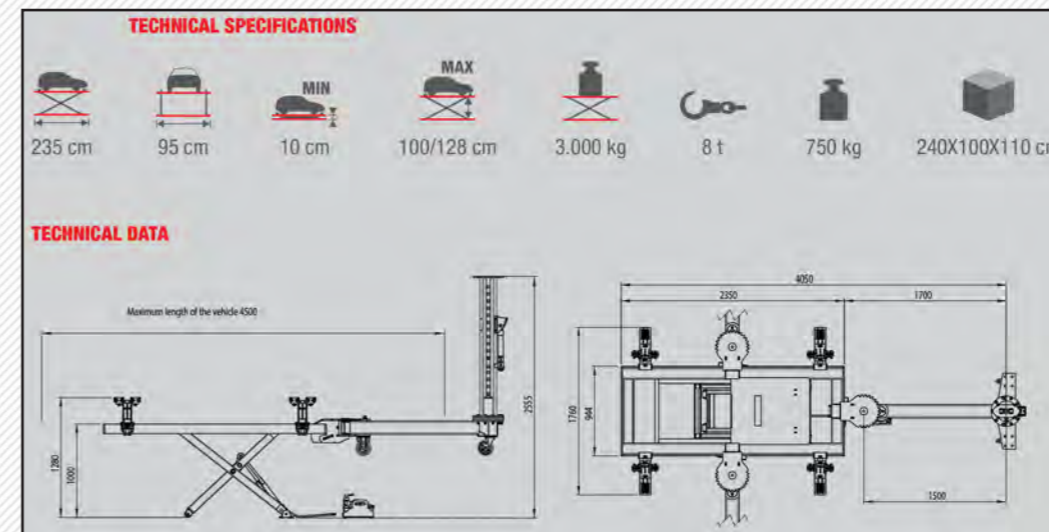

Panel Stands & Parts Racks

- └ Abrasives & Cleaning 2 - 5
- └ Polishing 6 -10
- └ Air Tools 11-15
- └ Compressors & Dryers 16-17
- └ Power Tools 18-25
- └ Hand Tools & Dollies 26-30
- └ Pulling Clamps 31-33
- └ Car Lifts & Dollies 34-37
- └ Panel Stands & Parts Racks 38-41**
- └ Floor Rack 42-44
- └ Tapes & Masking 45-47
- └ Mixing Cups & Liners 48-49
- └ Filters 50-52
- └ Spray Booth 53
- └ Dust Extraction 54-56
- └ Plastic Repair 57
- └ Dent Puller 58-61
- └ Spot Welder & MIG's 62-63
- └ Infrared & UVA LED Paint Curing Systems 64-67
- └ Tool Cabinets & Workbenches 68-71
- └ Solvent - Recyclers 72-75
- └ Solvent - Spray Gun & Pot Cleaners 76-78
- └ Waterborne - Recyclers, Waterborne - Spray Gun & Pot Cleaners 78-81
- └ Matrix Wand 82
- └ Wheel Aligner 83
- └ Bumper Sensor Kits 84-85
- └ Andreae 86
- └ Bossauto 87-88
- └ Etalon 89-91
- └ Fy-Tech 92-94
- └ Induction 95
- └ Meguro 96
- └ MWM 97
- └ Planit 98-101
- └ Stucchi 102
- └ Uniram 103-104



**3 Layer Parts Cart**  
SKU: BLPTY-05

Can mount panels and bumpers of any size and shape allowing easy access to both sides.



**Trolley**  
SKU: FY-9B-TROLLEY

Can be used to position and hold your work piece at a comfortable angle while you work on it.



**Masking Machine 18" (45.72cm)**  
SKU: BLP207-009



**Step Masking Machine 18"**  
SKU: BLP207-011



Panel Stands & Parts Racks

- 2 - 5 Abrasives & Cleaning
- 6 -10 Polishing
- 11-15 Air Tools
- 16-17 Compressors & Dryers
- 18-25 Power Tools
- 26-30 Hand Tools & Dollies
- 31-33 Pulling Clamps
- 34-37 Car Lifts & Dollies
- 38-41 Panel Stands & Parts Racks**
- 42-44 Floor Rack
- 45-47 Tapes & Masking
- 48-49 Mixing Cups & Liners
- 50-52 Filters
- 53 Spray Booth
- 54-56 Dust Extraction
- 57 Plastic Repair
- 58-61 Dent Puller
- 62-63 Spot Welder & MIG's
- 64-67 Infrared & UVA LED Paint Curing Systems
- 68-71 Tool Cabinets & Workbenches
- 72-75 Solvent - Recyclers
- 76-78 Solvent - Spray Gun & Pot Cleaners
- 78-81 Waterborne - Recyclers Waterborne - Spray Gun & Pot Cleaners
- 82 Matrix Wand
- 83 Wheel Aligner
- 84-85 Bumper Sensor Kits
- 86 Andreae
- 87-88 Bossauto
- 89-91 Etalon
- 92-94 Fy-Tech
- 95 Induction
- 96 Meguro
- 97 MWM
- 98-101 Planit
- 102 Stucchi
- 103-104 Uniram



**Curved Leg Portable Work Stand**  
SKU: BLPPB-3K-1

Great For Doors, Fenders, Hoods And Bumpers.  
Load capacity: 500Lbs  
Leg Tube Length: 77mm  
Steel Tubing Diameter: 28mm  
Steel Tubing Thickness : 1.2mm  
1/2" EPE Foam Will Cover Whole Arm



**Portable Work Stand**  
SKU: BLPPB-3K

Great for doors, fenders, hoods and bumpers.  
Load capacity: 500Lbs  
Leg Tube Length: 770mm  
Steel Tubing Diameter: 28mm  
Steel Tubing Thickness : 1.2mm  
1/2" EPE Foam Will Cover Whole Arm



**V Stand**  
SKU: BLPTY-PV

V Stand fits on to Panel / Work Stands and allows easy and sturdy mounting of bumpers.



**VW Stand**  
SKU: BLPTY-PV+W

VW Stand fits on to Panel / Work Stands and allows easy and sturdy mounting of multiple bumpers.



## Panel Stands & Parts Racks

- └ Abrasives & Cleaning 2-5
- └ Polishing 6-10
- └ Air Tools 11-15
- └ Compressors & Dryers 16-17
- └ Power Tools 18-25
- └ Hand Tools & Dollies 26-30
- └ Pulling Clamps 31-33
- └ Car Lifts & Dollies 34-37
- └ **Panel Stands & Parts Racks 38-41**
- └ Floor Rack 42-44
- └ Tapes & Masking 45-47
- └ Mixing Cups & Liners 48-49
- └ Filters 50-52
- └ Spray Booth 53
- └ Dust Extraction 54-56
- └ Plastic Repair 57
- └ Dent Puller 58-61
- └ Spot Welder & MIG's 62-63
- └ Infrared & UVA LED Paint Curing Systems 64-67
- └ Tool Cabinets & Workbenches 68-71
- └ Solvent - Recyclers 72-75
- └ Solvent - Spray Gun & Pot Cleaners 76-78
- └ Waterborne - Recyclers, Waterborne - Spray Gun & Pot Cleaners 78-81
- └ Matrix Wand 82
- └ Wheel Aligner 83
- └ Bumper Sensor Kits 84-85
- └ Andreae 86
- └ Bossauto 87-88
- └ Etalon 89-91
- └ Fy-Tech 92-94
- └ Induction 95
- └ Meguro 96
- └ MWM 97
- └ Planit 98-101
- └ Stucchi 102
- └ Uniram 103-104



**Rotating Panel Stand**  
SKU: BLPTY P42N

Can mount panels and bumpers of any size and shape allowing easy access to both sides.



**P04 Bonnet & Door Stand**  
SKU: BLPTY-P04

Can be used to position and hold your work piece at a comfortable angle while you work on it.



**T Bar Stand**  
SKU: BLP90303

An excellent adjustable workshop tool to hold items at a comfortable working height for both repair and painting jobs.



**T-BAR STAND with Wheels**  
SKU: BLP90303A

An excellent adjustable and mobile workshop tool to hold items at a comfortable working height for both repair and painting jobs.



**Double Sided Bumper Bar Stand**  
SKU: BLPTY P12

Holds up to 8 bumper covers.  
Steel tubing with powder coated finish



**Mobile Panel & Windshield Rack**  
SKU: BLPTY P29

Can hold up to 5 large panels or glass.  
Max weight 150kgs.  
Protective EPE Foam  
4 X 4" PP Castor (Two Swivel With Brake)



## Panel Stands & Parts Racks

- └ Abrasives & Cleaning 2-5
- └ Polishing 6-10
- └ Air Tools 11-15
- └ Compressors & Dryers 16-17
- └ Power Tools 18-25
- └ Hand Tools & Dollies 26-30
- └ Pulling Clamps 31-33
- └ Car Lifts & Dollies 34-37
- └ **Panel Stands & Parts Racks 38-41**
- └ Floor Rack 42-44
- └ Tapes & Masking 45-47
- └ Mixing Cups & Liners 48-49
- └ Filters 50-52
- └ Spray Booth 53
- └ Dust Extraction 54-56
- └ Plastic Repair 57
- └ Dent Puller 58-61
- └ Spot Welder & MIG's 62-63
- └ Infrared & UVA LED Paint Curing Systems 64-67
- └ Tool Cabinets & Workbenches 68-71
- └ Solvent - Recyclers 72-75
- └ Solvent - Spray Gun & Pot Cleaners 76-78
- └ Waterborne - Recyclers Waterborne - Spray Gun & Pot Cleaners 78-81
- └ Matrix Wand 82
- └ Wheel Aligner 83
- └ Bumper Sensor Kits 84-85
- └ Andreae 86
- └ Bossauto 87-88
- └ Etalon 89-91
- └ Fy-Tech 92-94
- └ Induction 95
- └ Meguro 96
- └ MWM 97
- └ Planit 98-101
- └ Stucchi 102
- └ Uniram 103-104



**Three Shelves Parts Cart**  
SKU: BLPTY P20M

Comes with 3 shelves for displaced car parts and 2 hanging arms. PU casters

Shelves fold away for easy storage of empty carts.  
890mm(W) x 760mm(D) x 1850mm(H)



**Three Shelves Parts Cart with Panel Train**  
SKU: BLPTY P20M-1

The folding rack with 8pc foam cushioned adjustable support arms for windscreen, sheet metals, hoods, doors, ...etc.

Shelves and arms fold away for easy storage of empty carts.  
1060mm(L) x 1330mm(W) x 1900mm(H)



**Wall Mounting Bumper Rack**  
SKU: BLPTY P15

Suitable for holding up to three bumpers of various lengths. Arms mountable in eight positions and can safely fold away. Mount to wall at desired width. H: 720mm D: 635mm



**Telescopic Universal Stand**  
SKU: BLPTY P21

Stable steel structure with telescopic spring. Anti-slip rubber cover to protect surface. The length is adjustable as need.  
4x4" rubber wheel

Max capacity: 100kg  
Width: 33-7/8 in (86cm)  
Min/Max Height: 84cm - 132cm  
Min/Max Length: 22.5cm - 138cm

Floor Rack

- └ Abrasives & Cleaning 2 - 5
- └ Polishing 6 -10
- └ Air Tools 11-15
- └ Compressors & Dryers 16-17
- └ Power Tools 18-25
- └ Hand Tools & Dollies 26-30
- └ Pulling Clamps 31-33
- └ Car Lifts & Dollies 34-37
- └ Panel Stands & Parts Racks 38-41
- └ **Floor Rack 42-44**
- └ Tapes & Masking 45-47
- └ Mixing Cups & Liners 48-49
- └ Filters 50-52
- └ Spray Booth 53
- └ Dust Extraction 54-56
- └ Plastic Repair 57
- └ Dent Puller 58-61
- └ Spot Welder & MIG's 62-63
- └ Infrared & UVA LED Paint Curing Systems 64-67
- └ Tool Cabinets & Workbenches 68-71
- └ Solvent - Recyclers 72-75
- └ Solvent - Spray Gun & Pot Cleaners 76-78
- └ Waterborne - Recyclers, Waterborne - Spray Gun & Pot Cleaners 78-81
- └ Matrix Wand 82
- └ Wheel Aligner 83
- └ Bumper Sensor Kits 84-85
- └ Andreae 86
- └ Bossauto 87-88
- └ Etalon 89-91
- └ Fy-Tech 92-94
- └ Induction 95
- └ Meguro 96
- └ MWM 97
- └ Planit 98-101
- └ Stucchi 102
- └ Uniram 103-104

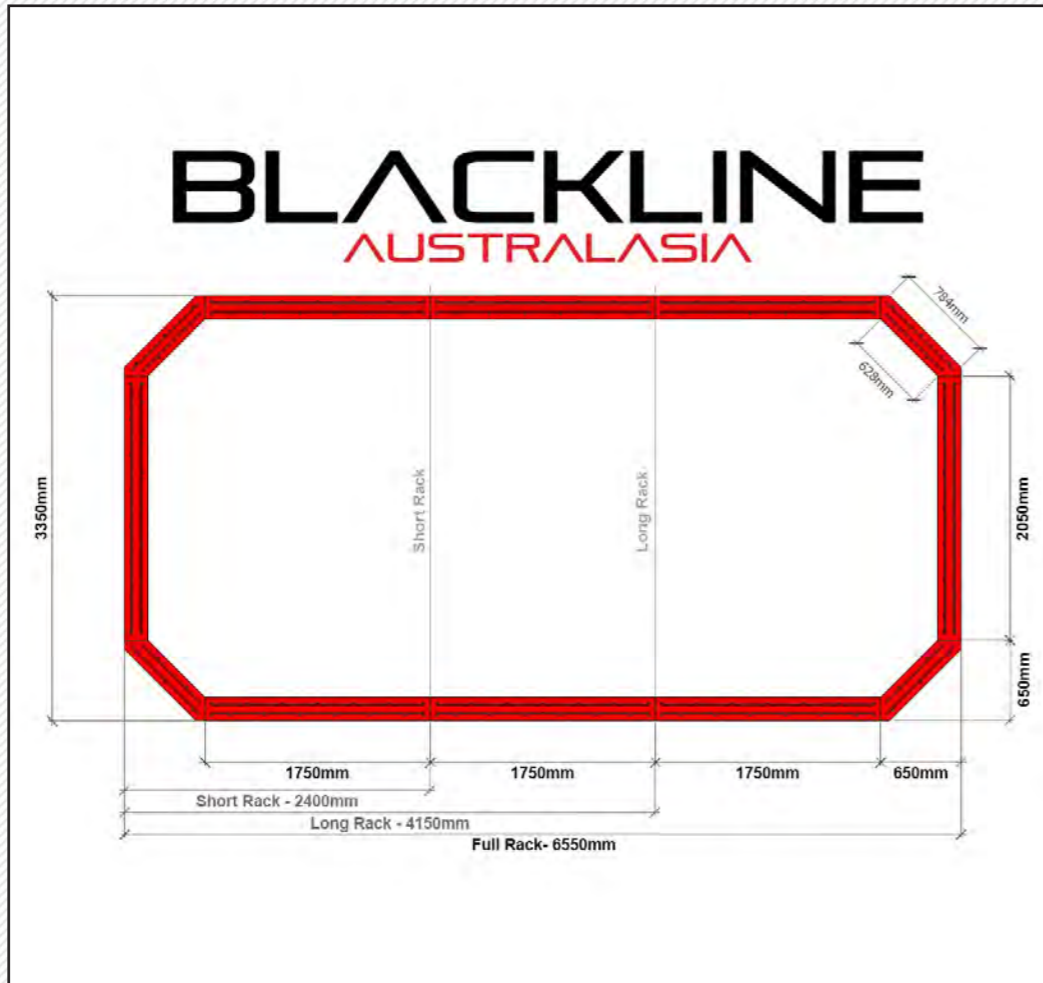

**Complete Flat Rack and Pulling Tower**  
SKU: BLPRACK

- Comes with:
- x2 Floor Rack End Plate – BLP5755-2
  - x6 Floor Rack Side Plate – BLP5755-1
  - x4 Floor Rack Corner Plate – BLP5755
  - x1 Pulling Tower Arm Extension – BLP5763
  - x1 PIN for Tower Arm – BLP5761
  - x1 Pulling Tower Arm – BLP5764
  - x1 Pulling Tower Base – BLP5769
  - x1 Ram 10ton – BLPRAM
  - x1 Chain 2.5m with Hook – BLPG70
  - x2 Grab Hook Plate for Floor Rack – BLP5753

\*Partial flat racks can also be purchased as Short or Long Racks



**Foot Pump**  
SKU: CMO2500700

Plunger: Ø 6,3 mm  
Pressure: 700 Bar  
Pumping capacity: 0,7 l/min  
Oil outlet threading: 3/8" Gas  
Air inlet threading: 1/4" Gas  
Oil tank capacity: 2,5 Lt



Floor Rack

- └ Abrasives & Cleaning 2 - 5
- └ Polishing 6 -10
- └ Air Tools 11-15
- └ Compressors & Dryers 16-17
- └ Power Tools 18-25
- └ Hand Tools & Dollies 26-30
- └ Pulling Clamps 31-33
- └ Car Lifts & Dollies 34-37
- └ Panel Stands & Parts Racks 38-41
- └ **Floor Rack 42-44**
- └ Tapes & Masking 45-47
- └ Mixing Cups & Liners 48-49
- └ Filters 50-52
- └ Spray Booth 53
- └ Dust Extraction 54-56
- └ Plastic Repair 57
- └ Dent Puller 58-61
- └ Spot Welder & MIG's 62-63
- └ Infrared & UVA LED Paint Curing Systems 64-67
- └ Tool Cabinets & Workbenches 68-71
- └ Solvent - Recyclers 72-75
- └ Solvent - Spray Gun & Pot Cleaners 76-78
- └ Waterborne - Recyclers Waterborne - Spray Gun & Pot Cleaners 78-81
- └ Matrix Wand 82
- └ Wheel Aligner 83
- └ Bumper Sensor Kits 84-85
- └ Andreae 86
- └ Bossauto 87-88
- └ Etalon 89-91
- └ Fy-Tech 92-94
- └ Induction 95
- └ Meguro 96
- └ MWM 97
- └ Planit 98-101
- └ Stucchi 102
- └ Uniram 103-104



**Pulling Tower Arm Extension**  
SKU: BLP5763

Upper Extension Arm

**Pulling Tower Arm**  
SKU: BLP5764

**Locking Pin For Tower Arm Extention**  
SKU: BLP5761

Main Pulling Arm with Locking Pin

Heavy duty securing pin.

**Pulling Tower Base**  
SKU: BLP5769

**Ram 10Ton**  
SKU: BLPRAM

Pulling Tower Base with Locking Pins

10ton Ram



**Floor Rack**

- └ Abrasives & Cleaning 2 - 5
- └ Polishing 6 - 10
- └ Air Tools 11-15
- └ Compressors & Dryers 16-17
- └ Power Tools 18-25
- └ Hand Tools & Dollies 26-30
- └ Pulling Clamps 31-33
- └ Car Lifts & Dollies 34-37
- └ Panel Stands & Parts Racks 38-41
- └ **Floor Rack 42-44**
- └ Tapes & Masking 45-47
- └ Mixing Cups & Liners 48-49
- └ Filters 50-52
- └ Spray Booth 53
- └ Dust Extraction 54-56
- └ Plastic Repair 57
- └ Dent Puller 58-61
- └ Spot Welder & MIG's 62-63
- └ Infrared & UVA LED Paint Curing Systems 64-67
- └ Tool Cabinets & Workbenches 68-71
- └ Solvent - Recyclers 72-75
- └ Solvent - Spray Gun & Pot Cleaners 76-78
- └ Waterborne - Recyclers, Waterborne - Spray Gun & Pot Cleaners 78-81
- └ Matrix Wand 82
- └ Wheel Aligner 83
- └ Bumper Sensor Kits 84-85
- └ Andreae 86
- └ Bossauto 87-88
- └ Etalon 89-91
- └ Fy-Tech 92-94
- └ Induction 95
- └ Meguro 96
- └ MWM 97
- └ Planit 98-101
- └ Stucchi 102
- └ Uniram 103-104



**Grab Hook Plate**  
SKU: BLP5753

Connects to floor rack to secure chains.

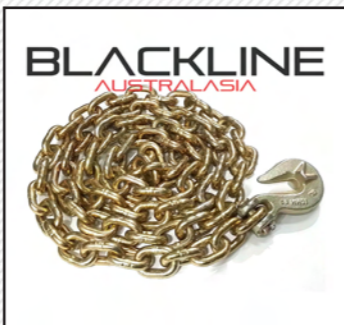

**Chain 2.5m with Hook**  
SKU: BLPG70

Chain for pulling.



**Pulling Pot**  
SKU: BLPPOT

Centre rotates 360° to secure chain.



**Porta Power Kit 10ton**  
SKU: BLPPPO10C

10,000 psi hand operated pump  
4 Heavy walled extension tubes 127mm, 250mm, 456mm and 685mm (5",10",18",27")

- Male connector
- Wedge head
- Serrated saddle
- Flat base
- Ram toe
- Plunger toe
- Rubber head
- Header and spreader

Internal pressure relief valve  
Portable – no need for a power source  
All steel construction  
Blow mold case

An essential hydraulic tool for automotive, truck, farm and heavy equipment repair pull, bend, lift, push, straighten and spread metals. This hydraulic Porta Power Kit contains a 10,000psi hand operated pump with multiple extensions and accessories for a variety of jobs around the workshop. Ideal for use in the automotive panel repair shop. The unit is protected by an internal pressure relief valve that helps prevent damage to rams and equipment and is supplied in a heavy duty plastic molded plastic carry case.



**Vehicle Anchoring System – CH-11**  
SKU: SKU: CH-11

Only 4cm above the ground, easier to drive on, saving a lot of time and improving work efficiency. The fixing plate is made from 8mm thick Q345B alloy steel. Four main clamps guarantee convenient connection with car. Save space, save time. No need to drive on and off to re position. Anchor is forged alloy steel to guarantee strength and safety.

**Tapes & Masking**

- └ Abrasives & Cleaning 2 - 5
- └ Polishing 6 - 10
- └ Air Tools 11-15
- └ Compressors & Dryers 16-17
- └ Power Tools 18-25
- └ Hand Tools & Dollies 26-30
- └ Pulling Clamps 31-33
- └ Car Lifts & Dollies 34-37
- └ Panel Stands & Parts Racks 38-41
- └ **Floor Rack 42-44**
- └ **Tapes & Masking 45-47**
- └ Mixing Cups & Liners 48-49
- └ Filters 50-52
- └ Spray Booth 53
- └ Dust Extraction 54-56
- └ Plastic Repair 57
- └ Dent Puller 58-61
- └ Spot Welder & MIG's 62-63
- └ Infrared & UVA LED Paint Curing Systems 64-67
- └ Tool Cabinets & Workbenches 68-71
- └ Solvent - Recyclers 72-75
- └ Solvent - Spray Gun & Pot Cleaners 76-78
- └ Waterborne - Recyclers Waterborne - Spray Gun & Pot Cleaners 78-81
- └ Matrix Wand 82
- └ Wheel Aligner 83
- └ Bumper Sensor Kits 84-85
- └ Andreae 86
- └ Bossauto 87-88
- └ Etalon 89-91
- └ Fy-Tech 92-94
- └ Induction 95
- └ Meguro 96
- └ MWM 97
- └ Planit 98-101
- └ Stucchi 102
- └ Uniram 103-104



**PLAN-IT Plastic 4.8M X 100M**  
SKU: PIMF48100

Corona treated, paintable & no flaking.



**Cover Mask Complete 1800 x 33M**  
SKU: PIMC180033

For quick and easily masking off areas prior to painting. Comes with easy cut strip.



**Cover Mask Refills 1800 x 33M**  
SKU: PIMR180033

Refil for cover mask complete for quickly and easily masking off areas prior to painting.



**RearView Mirror Double-Sided Tape Roll 50units 29x41mm**  
SKU: BOS040099

Double-sided adhesive pads for free hanging mirror support, such as interior rear-view mirrors.



**MASK '&' UP 10mm**  
SKU: BOSS100241

Tape pre-cut every 38 mm for use in bodywork.

The product consists of a paper strip with solvent based adhesive according to the characteristics attached, and a flexible polyester 190 my strip, 10 mm wide for 10 m of long, attached to one side of the paper tape. The characteristics of the tape allow supporting temperatures up to 70°C and leaves no residue once finished the application. Available only in countries with a valid patent.



**Logotrans**  
SKU: BOS100713

Double-sided adhesive tape totally transferring the glue only to the part in contact with it. Specially designed for attaching logos and emblems to the vehicle.





Tapes & Masking

- └ Abrasives & Cleaning 2-5
- └ Polishing 6-10
- └ Air Tools 11-15
- └ Compressors & Dryers 16-17
- └ Power Tools 18-25
- └ Hand Tools & Dollies 26-30
- └ Pulling Clamps 31-33
- └ Car Lifts & Dollies 34-37
- └ Panel Stands & Parts Racks 38-41
- └ Floor Rack 42-44
- └ Tapes & Masking 45-47
- └ Mixing Cups & Liners 48-49
- └ Filters 50-52
- └ Spray Booth 53
- └ Dust Extraction 54-56
- └ Plastic Repair 57
- └ Dent Puller 58-61
- └ Spot Welder & MIG's 62-63
- └ Infrared & UVA LED Paint Curing Systems 64-67
- └ Tool Cabinets & Workbenches 68-71
- └ Solvent - Recyclers 72-75
- └ Solvent - Spray Gun & Pot Cleaners 76-78
- └ Waterborne - Recyclers, Waterborne - Spray Gun & Pot Cleaners 78-81
- └ Matrix Wand 82
- └ Wheel Aligner 83
- └ Bumper Sensor Kits 84-85
- └ Andreae 86
- └ Bossauto 87-88
- └ Etalon 89-91
- └ Fy-Tech 92-94
- └ Induction 95
- └ Meguro 96
- └ MWM 97
- └ Planit 98-101
- └ Stucchi 102
- └ Uniram 103-104



MEGURO Sealing Tape  
16m x 10mm  
SKU: MST1610

MEGURO Sealing Tape  
16m x 8mm  
SKU: MST168

MEGURO Sealing Tape  
16m x 6mm  
SKU: MST166

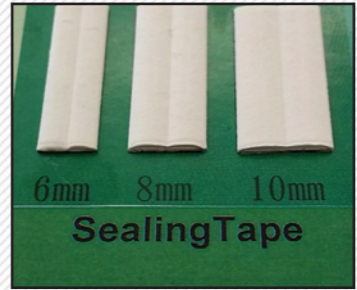

MEGURO Tape Roller  
SKU: MSMRST

Japanese company Meguro manufactures this patented seam tape used by many vehicle manufacturers on numerous vehicles. Accurately replicating OEM seam seal on many vehicles (not flat like other brands) & flexible enough to go around corners without cutting, Meguro seam seal tape gives an OEM result in no time. Just spray on the primer, apply the tape and it's ready to paint immediately!



MEGURO Primer 420ml  
SKU: MSTP420

Sealing tape primer is used to ensure secure bonding of the sealing tape to the panel. Download the MSDS sheet at [www.black-line.com.au](http://www.black-line.com.au)

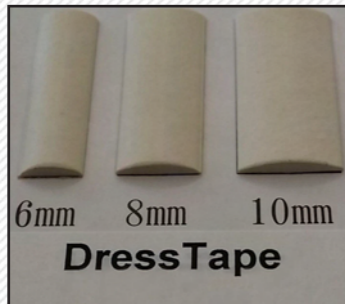

6mm 8mm 10mm  
DressTape



MEGURO Dress Tape  
9m x 10mm  
SKU: MSMDT910



MEGURO DressTape  
9m x 8mm  
SKU: MSMDT98



Tapes & Masking

- └ Abrasives & Cleaning 2-5
- └ Polishing 6-10
- └ Air Tools 11-15
- └ Compressors & Dryers 16-17
- └ Power Tools 18-25
- └ Hand Tools & Dollies 26-30
- └ Pulling Clamps 31-33
- └ Car Lifts & Dollies 34-37
- └ Panel Stands & Parts Racks 38-41
- └ Floor Rack 42-44
- └ Tapes & Masking 45-47
- └ Mixing Cups & Liners 48-49
- └ Filters 50-52
- └ Spray Booth 53
- └ Dust Extraction 54-56
- └ Plastic Repair 57
- └ Dent Puller 58-61
- └ Spot Welder & MIG's 62-63
- └ Infrared & UVA LED Paint Curing Systems 64-67
- └ Tool Cabinets & Workbenches 68-71
- └ Solvent - Recyclers 72-75
- └ Solvent - Spray Gun & Pot Cleaners 76-78
- └ Waterborne - Recyclers Waterborne - Spray Gun & Pot Cleaners 78-81
- └ Matrix Wand 82
- └ Wheel Aligner 83
- └ Bumper Sensor Kits 84-85
- └ Andreae 86
- └ Bossauto 87-88
- └ Etalon 89-91
- └ Fy-Tech 92-94
- └ Induction 95
- └ Meguro 96
- └ MWM 97
- └ Planit 98-101
- └ Stucchi 102
- └ Uniram 103-104



Masking Machine 18" (45.72cm)  
SKU: BLP207-009

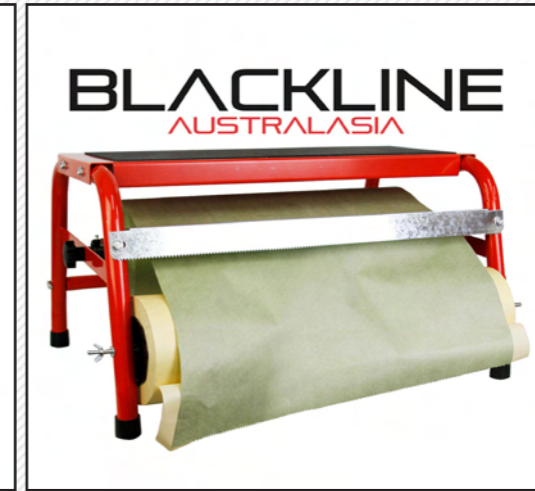

Step Masking Machine 18"  
SKU: BLP207-011



PlanIT Express Foam masking tape 13mm x 50m  
SKU: PI100713

A strip of adhesive foam for protecting door edges, trunk, hood and other openings on the vehicle, speeding up the protection process prior to painting, acting as a barrier preventing dust and paint from entering the inside of the vehicle. Supplied in individual boxes in strips of 10 x 5m x 13mm.



Foam masking tape XFOAM 13mm x 50m  
SKU: BOS100713

A strip of adhesive foam for protecting door edges, trunk, hood and other openings on the vehicle, speeding up the protection process prior to painting, acting as a barrier preventing dust and paint from entering the inside of the vehicle. Supplied in individual boxes in strips of 10 x 5m x 13mm.

The masking tape is easy and quick to apply and facilitates the whole repair process (masking). Mandrel with silicone paper coverage for a total use of the product. Developed by our research department to achieve a high quality finish.



## Mixing Cups & Liners

- └ Abrasives & Cleaning 2-5
- └ Polishing 6-10
- └ Air Tools 11-15
- └ Compressors & Dryers 16-17
- └ Power Tools 18-25
- └ Hand Tools & Dollies 26-30
- └ Pulling Clamps 31-33
- └ Car Lifts & Dollies 34-37
- └ Panel Stands & Parts Racks 38-41
- └ Floor Rack 42-44
- └ Tapes & Masking 45-47
- └ **Mixing Cups & Liners 48-49**
- └ Filters 50-52
- └ Spray Booth 53
- └ Dust Extraction 54-56
- └ Plastic Repair 57
- └ Dent Puller 58-61
- └ Spot Welder & MIG's 62-63
- └ Infrared & UVA LED Paint Curing Systems 64-67
- └ Tool Cabinets & Workbenches 68-71
- └ Solvent - Recyclers 72-75
- └ Solvent - Spray Gun & Pot Cleaners 76-78
- └ Waterborne - Recyclers, Waterborne - Spray Gun & Pot Cleaners 78-81
- └ Matrix Wand 82
- └ Wheel Aligner 83
- └ Bumper Sensor Kits 84-85
- └ Andreae 86
- └ Bossauto 87-88
- └ Etalon 89-91
- └ Fy-Tech 92-94
- └ Induction 95
- └ Meguro 96
- └ MWM 97
- └ Planit 98-101
- └ Stucchi 102
- └ Uniram 103-104



<p><b>PLANIT 190um Lid &amp; Liners</b> For Solvent Base. 50pack</p> <p>400ml <b>SKU: PIT400190</b></p> <p>600ml <b>SKU: PIT600190</b></p> <p>800ml <b>SKU: PIT800190</b></p>	<p><b>PLANIT 125um Lid &amp; Liners</b> For Water Base. 50pack</p> <p>600ml <b>SKU: PIT600125</b></p> <p>800ml <b>SKU: PIT800125</b></p>
---	--

**PLANIT Cup & Collar**  
2pack

Large Size  
**SKU: 8003**

Medium Size  
**SKU: 8002**

Small Size  
**SKU: 8007**



<b>GTI ADAPTOR</b> SKU: PIT08020	<b>IWATA ADAPTOR</b> SKU: PIT08021	<b>SATA ADAPTOR</b> SKU: PIT08022	<b>SATA QUICK RELEASE ADAPTOR</b> SKU: PIT08023
-------------------------------------	---------------------------------------	--------------------------------------	--

GTI Adaptor SKU: PIT08020	IWATA Adaptor SKU: PIT08021	SATA Adaptor SKU: PIT08022	SATA Quick Release Adaptor SKU: PIT08023
------------------------------	--------------------------------	-------------------------------	---

## Mixing Cups & Liners

- └ Abrasives & Cleaning 2-5
- └ Polishing 6-10
- └ Air Tools 11-15
- └ Compressors & Dryers 16-17
- └ Power Tools 18-25
- └ Hand Tools & Dollies 26-30
- └ Pulling Clamps 31-33
- └ Car Lifts & Dollies 34-37
- └ Panel Stands & Parts Racks 38-41
- └ Floor Rack 42-44
- └ Tapes & Masking 45-47
- └ **Mixing Cups & Liners 48-49**
- └ Filters 50-52
- └ Spray Booth 53
- └ Dust Extraction 54-56
- └ Plastic Repair 57
- └ Dent Puller 58-61
- └ Spot Welder & MIG's 62-63
- └ Infrared & UVA LED Paint Curing Systems 64-67
- └ Tool Cabinets & Workbenches 68-71
- └ Solvent - Recyclers 72-75
- └ Solvent - Spray Gun & Pot Cleaners 76-78
- └ Waterborne - Recyclers Waterborne - Spray Gun & Pot Cleaners 78-81
- └ Matrix Wand 82
- └ Wheel Aligner 83
- └ Bumper Sensor Kits 84-85
- └ Andreae 86
- └ Bossauto 87-88
- └ Etalon 89-91
- └ Fy-Tech 92-94
- └ Induction 95
- └ Meguro 96
- └ MWM 97
- └ Planit 98-101
- └ Stucchi 102
- └ Uniram 103-104



**TechCup 3800ml Calibrated Mixing Cup**  
**SKU: BOS100304**  
Hermetic seal.  
Disposable mixing cup for precise preparation of all types of paints.



**TechCup Glass Lid with Safety lock for 3800ml cup**  
Re-usable Hermetic Sealing Glass Lid for Tech-Cup.



**Paint Pot 5 Litre**  
**SKU: PI5LTB**  
The 5 Litre Paint Pot can be used with most standard paint systems that use a paint  
Material: PP  
Top diameter: 200mm  
Bottom diameter: 180mm  
Height: 195mm



**PLANIT Mixing Cup Lids**  
**SKU: PI-MCL2240**  
2240ml (400per Box)  
**SKU: PI-MCL1300**  
1300ml (400per Box)  
**SKU: PI-MCL0650**  
650ml (500per Box)  
**SKU: PI-MCL0400**  
400ml (500per Box)



**PLANIT Mixing Cups**  
200per Box

2240ml SKU: PI-MC2240	1300ml SKU: PI-MC1300	650ml SKU: PI-MC0650	400ml SKU: PI-MC0400
--------------------------	--------------------------	-------------------------	-------------------------



**Filters**

- └ Abrasives & Cleaning 2 - 5
- └ Polishing 6 - 10
- └ Air Tools 11-15
- └ Compressors & Dryers 16-17
- └ Power Tools 18-25
- └ Hand Tools & Dollys 26-30
- └ Pulling Clamps 31-33
- └ Car Lifts & Dollys 34-37
- └ Panel Stands & Parts Racks 38-41
- └ Floor Rack 42-44
- └ Tapes & Masking 45-47
- └ Mixing Cups & Liners 48-49
- └ **Filters** 50-52
- └ Spray Booth 53
- └ Dust Extraction 54-56
- └ Plastic Repair 57
- └ Dent Puller 58-61
- └ Spot Welder & MIG's 62-63
- └ Infrared & UVA LED Paint Curing Systems 64-67
- └ Tool Cabinets & Workbenches 68-71
- └ Solvent - Recyclers 72-75
- └ Solvent - Spray Gun & Pot Cleaners 76-78
- └ Waterborne - Recyclers, Waterborne - Spray Gun & Pot Cleaners 78-81
- └ Matrix Wand 82
- └ Wheel Aligner 83
- └ Bumper Sensor Kits 84-85
- └ Andreae 86
- └ Bossauto 87-88
- └ Etalon 89-91
- └ Fy-Tech 92-94
- └ Induction 95
- └ Meguro 96
- └ MWM 97
- └ Planit 98-101
- └ Stucchi 102
- └ Uniram 103-104



**190micron Paper Cone Filters**  
SKU: PI-0003-190  
Solvent Borne Filter  
(Sleeves of 250)  
or (Carton of 1000)



**125micron Paper Cone Filters**  
SKU: PI-0003-125  
Water Borne Filter  
(Sleeves of 250)  
or (Carton of 1000)



**Andreae Concertina Filter**  
100cm SKU: ANDAF113  
90cm SKU: ANDAF813

Made out of 2 layers of heavy "Kraft" paper, punched, pleated and glued together with 2 built-in extension limiters. Thanks to these limiters, the maximum load capacity is guaranteed.



**Andreae Concertina High Efficiency 90cm Filter**  
SKU: ANDAF923

The Andreae High Efficiency Filter will bring a filtration efficiency near 100% while keeping the high loading capacity of the Andreae filter. The High Efficiency Filter is made out of 2 layers of heavy 'Kraft' paper, punched, pleated and glued together completed with a polyester layer on its back increasing its filtration efficiency.

The v-shaped front wall prevents over spray bounce back and particle migration. The deeper v-shape back wall captures over spray and deposits it outside of the airflow. The filter exhaust holes are positioned to maintain constant airflow during the loading phase. Static pressure increases slowly with the accumulation of over spray resulting in uniform airflow.

**PlanIT Fiberglass Water Borne Filter 75cm x 20m**  
SKU: PI0030

Composited of continuous monofilament glass fiberglass and it is progressively encrypted from the inlet side to the outlet side in fluffy state.

It is used in heat recovery systems and high-quality paint mist filtration of surface coating with the high rate of capturing particles and long life-cycle.

Temperature resistance: 170 ° C  
Conforming to the European DIN53438-F1  
The average mist capturing rate: 93-97%.

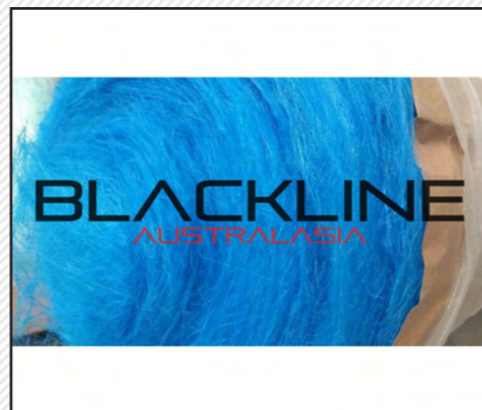

**PlanIT Fiberglass Exhaust Filter**

Composited of continuous monofilament glass fiberglass and it is progressively encrypted from the inlet side to the outlet side in fluffy state.

It is used in heat recovery systems and high-quality paint mist filtration of surface coating with the high rate of capturing particles and long life-cycle.

The inlet side is green, outlet side is white with good compressibility properties to ensure its stability & strong nature and to ensure that filter is not loose, scattered, and more conducive to store mist and dust.

Temperature resistance: 170 ° C  
Conforming to the European DIN53438-F1  
The average mist capturing rate: 93-97%.



**Clean Air Flow Ceiling Filters**  
560 Grade

(1.2m x 23m) 565G SKU: PI0023  
(1.6m x 13m) 565G SKU: PI0024  
(2.0m x 20m) 565G SKU: PI0025

Rolls can be cut into Pads at a Per Meter Charge.



**Clean Air Flow Ceiling Filters**  
660 Grade

(1.0m x 20m) 665G SKU: PI0012  
(1.2m x 23m) 665G SKU: PI0013  
(1.5m x 16m) 665G SKU: PI0010  
(1.6m x 13m) 665G SKU: PI0014  
(2.0m x 20m) 665G SKU: PI0011

Rolls can be cut into Pads at a Per Meter Charge.

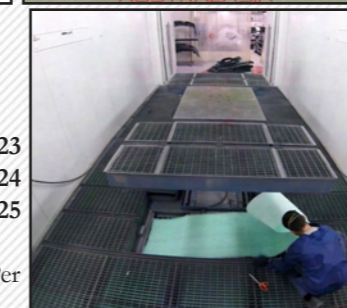

**Sizes & Part Numbers**

(500cm x 20m) SKU: PI0001
(750cm x 20m) SKU: PI0004
(1000cm x 20m) SKU: PI0006
(1250cm x 20m) SKU: PI0007
(1500cm x 20m) SKU: PI0008
(2000cm x 20m) SKU: PI0009

**Filters**

- └ Abrasives & Cleaning 2 - 5
- └ Polishing 6 - 10
- └ Air Tools 11-15
- └ Compressors & Dryers 16-17
- └ Power Tools 18-25
- └ Hand Tools & Dollys 26-30
- └ Pulling Clamps 31-33
- └ Car Lifts & Dollys 34-37
- └ Panel Stands & Parts Racks 38-41
- └ Floor Rack 42-44
- └ Tapes & Masking 45-47
- └ Mixing Cups & Liners 48-49
- └ **Filters** 50-52
- └ Spray Booth 53
- └ Dust Extraction 54-56
- └ Plastic Repair 57
- └ Dent Puller 58-61
- └ Spot Welder & MIG's 62-63
- └ Infrared & UVA LED Paint Curing Systems 64-67
- └ Tool Cabinets & Workbenches 68-71
- └ Solvent - Recyclers 72-75
- └ Solvent - Spray Gun & Pot Cleaners 76-78
- └ Waterborne - Recyclers Waterborne - Spray Gun & Pot Cleaners 78-81
- └ Matrix Wand 82
- └ Wheel Aligner 83
- └ Bumper Sensor Kits 84-85
- └ Andreae 86
- └ Bossauto 87-88
- └ Etalon 89-91
- └ Fy-Tech 92-94
- └ Induction 95
- └ Meguro 96
- └ MWM 97
- └ Planit 98-101
- └ Stucchi 102
- └ Uniram 103-104



**Filters**

- └ Abrasives & Cleaning 2 - 5
- └ Polishing 6 - 10
- └ Air Tools 11-15
- └ Compressors & Dryers 16-17
- └ Power Tools 18-25
- └ Hand Tools & Dollies 26-30
- └ Pulling Clamps 31-33
- └ Car Lifts & Dollies 34-37
- └ Panel Stands & Parts Racks 38-41
- └ Floor Rack 42-44
- └ Tapes & Masking 45-47
- └ Mixing Cups & Liners 48-49
- └ **Filters 50-52**
- └ Spray Booth 53
- └ Dust Extraction 54-56
- └ Plastic Repair 57
- └ Dent Puller 58-61
- └ Spot Welder & MIG's 62-63
- └ Infrared & UVA LED Paint Curing Systems 64-67
- └ Tool Cabinets & Workbenches 68-71
- └ Solvent - Recyclers 72-75
- └ Solvent - Spray Gun & Pot Cleaners 76-78
- └ Waterborne - Recyclers, Waterborne - Spray Gun & Pot Cleaners 78-81
- └ Matrix Wand 82
- └ Wheel Aligner 83
- └ Bumper Sensor Kits 84-85
- └ Andreae 86
- └ Bossauto 87-88
- └ Etalon 89-91
- └ Fy-Tech 92-94
- └ Induction 95
- └ Meguro 96
- └ MWM 97
- └ Planit 98-101
- └ Stucchi 102
- └ Uniram 103-104

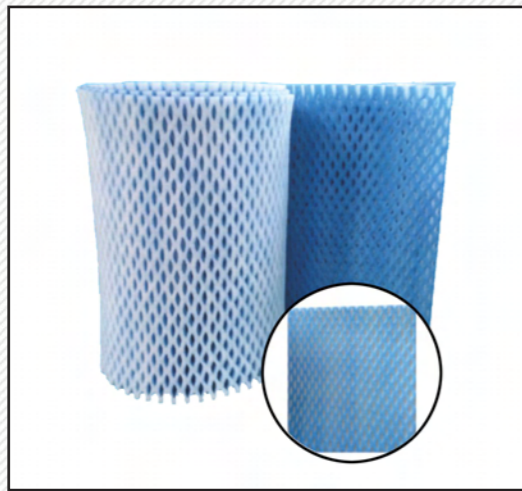

**Pocket Exhaust Filter 75cm x 22m**  
SKU: PI0022

Paint Pocket is the most effective and most economical way to manage the over spray produced by common coatings including medium and high solids paints, powder coatings, water reduced paints, stains, and adhesives.

**Low Run-Off**

Paint Pocket now only removes over spray from your booth's exhaust air stream, its pockets assist in retaining over spray with the arrestor. Reduced run-off means less booth floor clean-up and faster filter changes.

**Stable Air Flow**

Its unique pockets enable Paint Pocket to accumulate large amount quantities of over spray before it begins to noticeable restrict booth airflow.

**PlanIT Pre Filter**

1m x 32m SKU: PI0021  
2m x 20m SKU: PI0018

Consisted of special organic synthetic fiber, is high-density pocket filter.

This series of filters is designed for general ventilation and the entrance of air control series as pre-filtration or coarse filtration.

It's processed by high-performance synthetic fiber in gradual technology. Large dust holding capacity and low initial resistance, economical and practical.



**Spray Booth**

- └ Abrasives & Cleaning 2 - 5
- └ Polishing 6 - 10
- └ Air Tools 11-15
- └ Compressors & Dryers 16-17
- └ Power Tools 18-25
- └ Hand Tools & Dollies 26-30
- └ Pulling Clamps 31-33
- └ Car Lifts & Dollies 34-37
- └ Panel Stands & Parts Racks 38-41
- └ Floor Rack 42-44
- └ Tapes & Masking 45-47
- └ Mixing Cups & Liners 48-49
- └ **Filters 50-52**
- └ **Spray Booth 53**
- └ Dust Extraction 54-56
- └ Plastic Repair 57
- └ Dent Puller 58-61
- └ Spot Welder & MIG's 62-63
- └ Infrared & UVA LED Paint Curing Systems 64-67
- └ Tool Cabinets & Workbenches 68-71
- └ Solvent - Recyclers 72-75
- └ Solvent - Spray Gun & Pot Cleaners 76-78
- └ Waterborne - Recyclers Waterborne - Spray Gun & Pot Cleaners 78-81
- └ Matrix Wand 82
- └ Wheel Aligner 83
- └ Bumper Sensor Kits 84-85
- └ Andreae 86
- └ Bossauto 87-88
- └ Etalon 89-91
- └ Fy-Tech 92-94
- └ Induction 95
- └ Meguro 96
- └ MWM 97
- └ Planit 98-101
- └ Stucchi 102
- └ Uniram 103-104

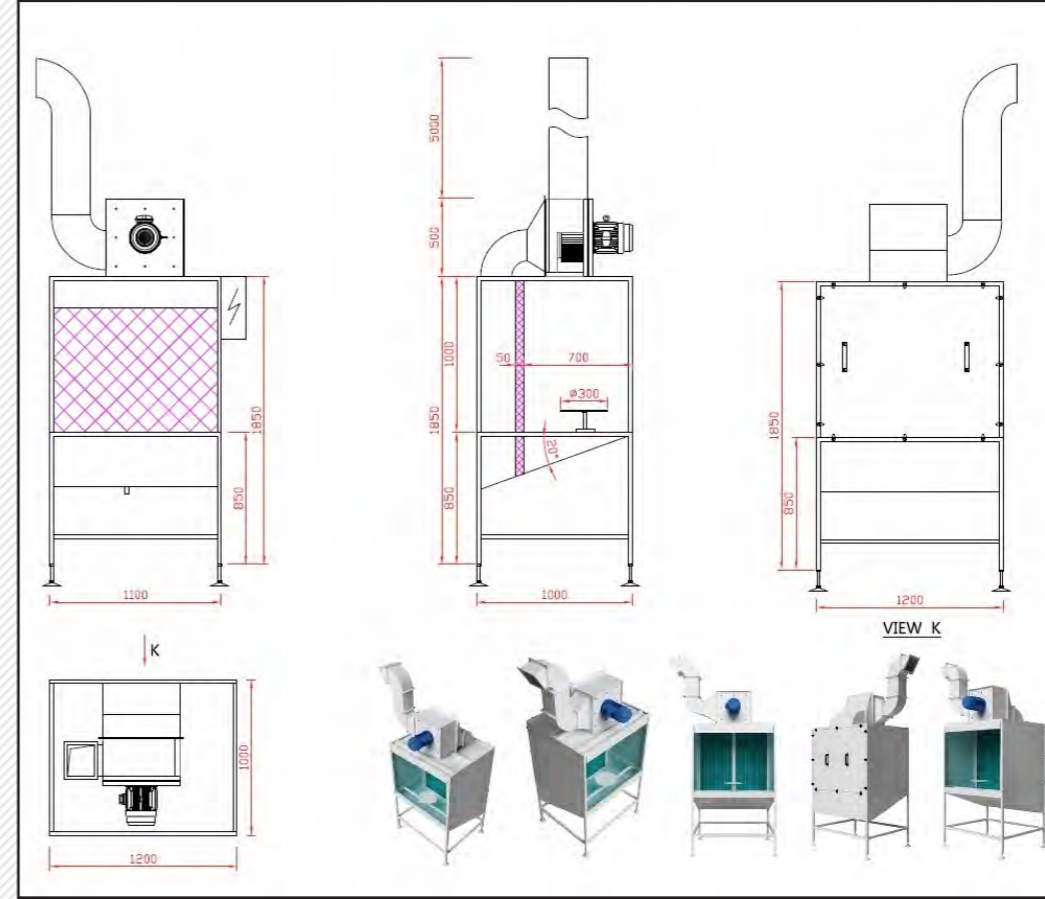

**Spray Cabinet**  
SKU: GSI-001

Outside Size: 1200Lx1000Wx1850Hmmm

Cabinet Opening: 1140w x 670h x 690d

Wall Panel: 1.2mm Galvanized bending steel, powder coated. (The rear panel can be taken off for cleaning.)

Roof Panel: 2.0mm Galvanized steel, powder coated.

Ceiling Light: 1 unit lighting fixtures equipped with 1 anti-explosion tubes of 20 Watts.



**Exhaust Air Units**

Motor and Fan: Air exhausts from the top side.

Motor: 1pc external setting; single motor power 1.5KW, total power:1.5KW.

Fan type: axial fan, BAF-300 anti-explosion motor, total air capacity: 3000m3/h.

Filter: Fibre glass filter, G3 Grade(EN779),type is PA-50.

Exhaust Air Duct: 1.5M long extension pipeline.

**Control System**

Voltage: 1x 220V, 50HZ.

Switch: Power, Lighting, Fan.



**Dust Extraction**

- └ Abrasives & Cleaning 2 - 5
- └ Polishing 6 -10
- └ Air Tools 11-15
- └ Compressors & Dryers 16-17
- └ Power Tools 18-25
- └ Hand Tools & Dollies 26-30
- └ Pulling Clamps 31-33
- └ Car Lifts & Dollies 34-37
- └ Panel Stands & Parts Racks 38-41
- └ Floor Rack 42-44
- └ Tapes & Masking 45-47
- └ Mixing Cups & Liners 48-49
- └ Filters 50-52
- └ Spray Booth 53
- └ **Dust Extraction 54-56**
- └ Plastic Repair 57
- └ Dent Puller 58-61
- └ Spot Welder & MIG's 62-63
- └ Infrared & UVA LED Paint Curing Systems 64-67
- └ Tool Cabinets & Workbenches 68-71
- └ Solvent - Recyclers 72-75
- └ Solvent - Spray Gun & Pot Cleaners 76-78
- └ Waterborne - Recyclers, Waterborne - Spray Gun & Pot Cleaners 78-81
- └ Matrix Wand 82
- └ Wheel Aligner 83
- └ Bumper Sensor Kits 84-85
- └ Andreae 86
- └ Bossauto 87-88
- └ Etalon 89-91
- └ Fy-Tech 92-94
- └ Induction 95
- └ Meguro 96
- └ MWM 97
- └ Planit 98-101
- └ Stucchi 102
- └ Uniram 103-104

Industrial aspirator on wheels with 24V AC controls, CEE standards, Robust and compact form, manual adjustment of the aspiration. Automatic pneumatic and electrical controls.  
Reserve tank for cleaning the filters.

Reserve tank for cleaning the filters. Complete with 5m suction hose.



**Dust Exhauster ST1-C**  
SKU: ST1-C

Supply voltage : 230 V 50/60Hz  
Control voltage : 12 Volt  
Suction Volume : 300 m<sup>3</sup>/h  
Suction vacuum : 210 mbar  
Supply air pressure: Max 8 bar  
Suction Turbine: 1,3 + 1,3 kW  
Noise : 67 dBa  
Dimensioni : 450 x 450 x 800mm



**Dust Exhauster ST2-C**  
SKU: ST2-C

Supply voltage : 230 V 50/60Hz  
Control voltage : 12 Volt  
Suction Volume : 300 m<sup>3</sup>/h  
Suction vacuum : 210 mbar  
Supply air pressure: Max 8 bar  
Suction Turbine: 1,3 + 1,3 kW  
Noise : 67 dBa  
Dimensioni : 450 x 450 x 800mm



**Dust Exhauster M1-JOLLY**  
SKU: M1-JOLLY

Suction bench for special works, manual works or using tools with or without suction.  
Vertical cartridge filter to collect dust in the removable pockets with manual opening.  
MANUAL START  
Optional Extras: Wheels , external exhaust, side extension and explosion-proof motor for aluminum and carbon.



Supply voltage: 220V 50/60Hz  
Control voltage: 12 Volt  
Suction volume: 2000 M3/h  
Suction turbine with automatic start:  
280 W – 3 Speed  
Dimensions: 800 x 1000 x 900mm

**Dust Extraction**

- └ Abrasives & Cleaning 2 - 5
- └ Polishing 6 -10
- └ Air Tools 11-15
- └ Compressors & Dryers 16-17
- └ Power Tools 18-25
- └ Hand Tools & Dollies 26-30
- └ Pulling Clamps 31-33
- └ Car Lifts & Dollies 34-37
- └ Panel Stands & Parts Racks 38-41
- └ Floor Rack 42-44
- └ Tapes & Masking 45-47
- └ Mixing Cups & Liners 48-49
- └ Filters 50-52
- └ Spray Booth 53
- └ **Dust Extraction 54-56**
- └ Plastic Repair 57
- └ Dent Puller 58-61
- └ Spot Welder & MIG's 62-63
- └ Infrared & UVA LED Paint Curing Systems 64-67
- └ Tool Cabinets & Workbenches 68-71
- └ Solvent - Recyclers 72-75
- └ Solvent - Spray Gun & Pot Cleaners 76-78
- └ Waterborne - Recyclers Waterborne - Spray Gun & Pot Cleaners 78-81
- └ Matrix Wand 82
- └ Wheel Aligner 83
- └ Bumper Sensor Kits 84-85
- └ Andreae 86
- └ Bossauto 87-88
- └ Etalon 89-91
- └ Fy-Tech 92-94
- └ Induction 95
- └ Meguro 96
- └ MWM 97
- └ Planit 98-101
- └ Stucchi 102
- └ Uniram 103-104



**KIT PC-1**  
SKU: KIT PC-1

The PC-1 Kit is a sturdy shelf attachment that adds versatility and mobile storage to your ST1 or ST2.



**Dust Exhauster ST2-COMBI**  
SKU: ST2-COMBI

Industrial aspirator on wheels with an integrated vacuum table, single-phase high-performance motors. Robust and compact form, manual adjustment of the aspiration. Automatic and manual filter cleaning. Automatic and pneumatic electrical controls. Vacuum table converts to a table top, magnetic media for random orbital sanders, storage shelves, waste bin and many other options to customize your ST2-Combi.  
Supply Voltage : 230 V 50/60Hz  
Control voltage : 12 Volt  
Suction volume : 300 m<sup>3</sup>/h  
Suction vacuum: 210 mbar  
Supply air pressure: Max 8 bar  
Suction turbine: 1,3 + 1,3 kW  
Noise: 68 dBa  
Dimensions: 500 x 1000 x 900 mm



**Dust Exhauster ME-1**  
SKU: ME-1

Supply voltage: 230V 50/60Hz  
Control Voltage: 12 Volt  
Suction volume: 150 m<sup>3</sup>/h  
Suction vacuum : 210 mbar  
Supply air pressure: Max 8bar  
Suction turbine: 1,3kW  
Noise: 67 dBa  
Dimensions: 500 x 400 x 2000mm

Suction module recessed, ideal for areas of preparation. Simple installation and implementation  
One or Two Single-phase turbines  
Self-cleaning filter system that does not need any maintenance. The convenient front pockets allows you to store the hoses inside. Comes equipped with air flow regulators and can use both electric and pneumatic dry air.

**Dust Exhauster ME-1P**  
SKU: ME-1P

Supply voltage: 230V 50/60Hz  
Control Voltage: 12 Volt  
Suction volume: 300 m<sup>3</sup>/h  
Suction vacuum : 210 mbar  
Supply air pressure: Max 8bar  
Suction turbine: 1,3+ 1,3kW  
Noise: 72 dBa  
Dimensions: 500 x 400 x 2000 mm



## Dust Extraction

- └ Abrasives & Cleaning 2-5
- └ Polishing 6-10
- └ Air Tools 11-15
- └ Compressors & Dryers 16-17
- └ Power Tools 18-25
- └ Hand Tools & Dollies 26-30
- └ Pulling Clamps 31-33
- └ Car Lifts & Dollies 34-37
- └ Panel Stands & Parts Racks 38-41
- └ Floor Rack 42-44
- └ Tapes & Masking 45-47
- └ Mixing Cups & Liners 48-49
- └ Filters 50-52
- └ Spray Booth 53
- └ **Dust Extraction 54-56**
- └ Plastic Repair 57
- └ Dent Puller 58-61
- └ Spot Welder & MIG's 62-63
- └ Infrared & UVA LED Paint Curing Systems 64-67
- └ Tool Cabinets & Workbenches 68-71
- └ Solvent - Recyclers 72-75
- └ Solvent - Spray Gun & Pot Cleaners 76-78
- └ Waterborne - Recyclers, Waterborne - Spray Gun & Pot Cleaners 78-81
- └ Matrix Wand 82
- └ Wheel Aligner 83
- └ Bumper Sensor Kits 84-85
- └ Andreae 86
- └ Bossauto 87-88
- └ Etalon 89-91
- └ Fy-Tech 92-94
- └ Induction 95
- └ Meguro 96
- └ MWM 97
- └ Planit 98-101
- └ Stucchi 102
- └ Uniram 103-104

These arms are used to support and enable the handling of multifunctional hexagons. Available in B5 (5 meters) and B6 (6 meters), these arms are used to support and enable the handling of multifunctional hexagons (EM and ESM-PT)

The arms are mounted to the wall by means of a support bracket and enable operators to reach the working position within a radius of five or six meters, with 180° rotation, eliminating the clutter of electrical cables, tubes for compressed air and suction tubes.



**Articulated Arm B5**  
SKU: B5  
Overall length: 5m



**Articulated Arm B6**  
SKU: B6  
Overall length: 6m



**Dust Exhauster ST1-M**  
SKU: ST1-M  
Supply voltage: 230V 50/60Hz  
Control supply: 12 Volt  
Suction volume: 150m<sup>3</sup>/h  
Suction vacuum : 210mbar  
Supply air pressure: Max 8bar  
Suction turbine: 1,3kW  
Noise: 67dBa  
Dimensions: 450 x 450 x 800mm

Industrial vacuum cleaner for wall installation.  
Automatic and adjustable suction.  
Automatic and manual start of the single-phase turbine.  
Self-cleaning filter system.  
Ideal for connection to the articulated arm.  
Comes complete with support bracket.



**Multipurpose Hexagon EM**  
SKU: EM  
x1 Dry air and regulated control manometer  
x1 Automatic air tool  
x1 Socket 220V automatic tool  
x1 Suction nozzle  
x1 Manual closing system of the aspiration



**Multipurpose Hexagon ESM-PT**  
SKU: ESM-PT  
x1 Dry air and regulated control manometer  
x2 Automatic air tool  
x2 Socket 220V automatic tool  
x2 Suction nozzle  
x2 Manual closing system of the aspiration

The suction system can be started using the remote start selector present on the hexagon. The hexagons are also fitted with a manual device to stop the suction flow (cut-off switch) that guarantees maximum suction performance.

## Plastic Repair

- └ Abrasives & Cleaning 2-5
- └ Polishing 6-10
- └ Air Tools 11-15
- └ Compressors & Dryers 16-17
- └ Power Tools 18-25
- └ Hand Tools & Dollies 26-30
- └ Pulling Clamps 31-33
- └ Car Lifts & Dollies 34-37
- └ Panel Stands & Parts Racks 38-41
- └ Floor Rack 42-44
- └ Tapes & Masking 45-47
- └ Mixing Cups & Liners 48-49
- └ Filters 50-52
- └ Spray Booth 53
- └ **Dust Extraction 54-56**
- └ **Plastic Repair 57**
- └ Dent Puller 58-61
- └ Spot Welder & MIG's 62-63
- └ Infrared & UVA LED Paint Curing Systems 64-67
- └ Tool Cabinets & Workbenches 68-71
- └ Solvent - Recyclers 72-75
- └ Solvent - Spray Gun & Pot Cleaners 76-78
- └ Waterborne - Recyclers Waterborne - Spray Gun & Pot Cleaners 78-81
- └ Matrix Wand 82
- └ Wheel Aligner 83
- └ Bumper Sensor Kits 84-85
- └ Andreae 86
- └ Bossauto 87-88
- └ Etalon 89-91
- └ Fy-Tech 92-94
- └ Induction 95
- └ Meguro 96
- └ MWM 97
- └ Planit 98-101
- └ Stucchi 102
- └ Uniram 103-104



**Multifunctional Plastic Welder Repair Kit**  
SKU: FY-2012S

Using a new type of resistance short circuit design and a clip which can be used on both sides to prolong the service life. Digital control system allows easy selection of functions, stepless control of power and free adjustment of parameters, convenient to use. Complete with different staples for repairing different parts like the car bumper, plastic parts and plastic surfaces.  
Input Voltage: AC 230V 50/60Hz. Input Current: 1.5A  
Output Voltage: 2.6V Output Current: 5-6.8A

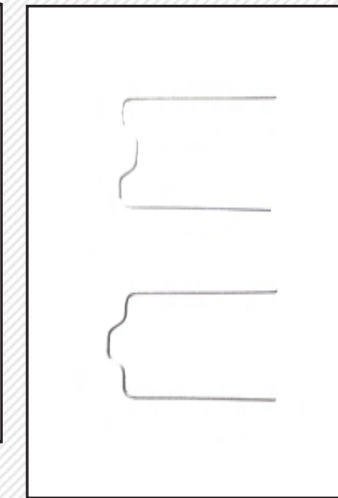

**Plastic Repair Staples**  
Inverted  
SKU: MWM31069  
Straight  
SKU: MWM31068



**Plastic Welding Repair Kit**  
SKU: IMM91200  
Power: 1600W  
Frequency: 50-60HZ  
Temperature: 20-650°C  
Min airflow(20°C): 300L/min  
Size of air inlet: ø19mm  
Size of air outlet: ø26mm

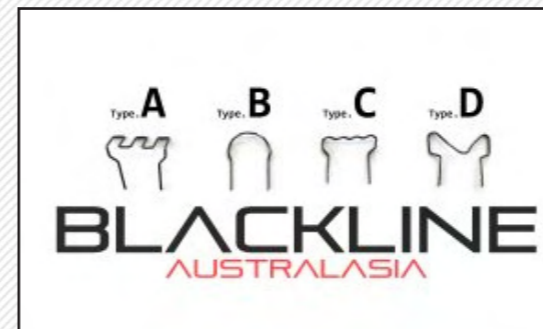

**Plastic Weld Pin**  
Type. A SKU: FYB001A Type. B SKU: FYB001B  
Type. C SKU: FYB001C Type. D SKU: FYB001D



**Hot Stapler Plastic Repair Kit**  
SKU: PIHSPRK  
Input voltage: 1ph 240V 60Hz (110V 50Hz)  
Input power: 40-100W



**Dent Pullers**

- └ Abrasives & Cleaning 2 - 5
- └ Polishing 6 -10
- └ Air Tools 11-15
- └ Compressors & Dryers 16-17
- └ Power Tools 18-25
- └ Hand Tools & Dollys 26-30
- └ Pulling Clamps 31-33
- └ Car Lifts & Dollys 34-37
- └ Panel Stands & Parts Racks 38-41
- └ Floor Rack 42-44
- └ Tapes & Masking 45-47
- └ Mixing Cups & Liners 48-49
- └ Filters 50-52
- └ Spray Booth 53
- └ Dust Extraction 54-56
- └ Plastic Repair 57
- └ Dent Puller 58-61
- └ Spot Welder & MIG's 62-63
- └ Infrared & UVA LED Paint Curing Systems 64-67
- └ Tool Cabinets & Workbenches 68-71
- └ Solvent - Recyclers 72-75
- └ Solvent - Spray Gun & Pot Cleaners 76-78
- └ Waterborne - Recyclers, Waterborne - Spray Gun & Pot Cleaners 78-81
- └ Matrix Wand 82
- └ Wheel Aligner 83
- └ Bumper Sensor Kits 84-85
- └ Andreae 86
- └ Bossauto 87-88
- └ Etalon 89-91
- └ Fy-Tech 92-94
- └ Induction 95
- └ Meguro 96
- └ MWM 97
- └ Planit 98-101
- └ Stucchi 102
- └ Uniram 103-104



**Paintless Dent Removal**  
**SKU: FYHI-1100W**

Only need 20 Seconds to repair the dents  
Car body collision repair is an advanced technology for repairing various dents on the car body caused by strike or impact.  
Compared with traditional repair processes, PDR can offer shorter repair time, better repair result and less labor cost. Suitable for use on repairing car doors, bonnets, trunk lids..etc.

- 1.Environment friendly product without welding, puttying and painting.
- 2.Electromagnetic tool with advance technology, easy to use.
- 3.Compact size, low cost investment and high return
- 4.Quick and easy way to repair car body without damaging body paint
- 5.Extensive use, simple way to repair the dent of car body.



**Multifunctional Aluminum Dent Pulling Machine**  
**SKU: FY-65L**

As time goes on, more and more car panels are made of aluminium. With advanced welding power and control technology, FY-65L are specifically designed for aluminium panel repairs of BMW, Mercedes-Benz, Audi and Volvo amongst others. Whilst specially designed for aluminium body repair works, it is also suitable for use on other metals such as steel, copper and iron.

With leading international inverter technology. Microprocessor control system optimizes the welding parameters. Due to the adoption of advanced digital control technology and user friendly design, all you have to do is select the welding current corresponding to the workpiece thickness to achieve the best weld quality.  
High precision power control system.  
Complete with two and four-kickstand crossbar lifters to accommodate any repair task for the whole aluminium car body.  
Suitable for dent pulling of aluminium and different kinds of car steels.  
High welding strength without damage to the metallic coatings and paint surfaces on the back.  
Digital display, simple to operate and easy to use.  
Able to weld 3mm-8mm aluminium stud bolts, steel stud bolts and aluminium washers.  
Additional aluminium MIG welder is available as an option.



**Dent Pullers**

- └ Abrasives & Cleaning 2 - 5
- └ Polishing 6 -10
- └ Air Tools 11-15
- └ Compressors & Dryers 16-17
- └ Power Tools 18-25
- └ Hand Tools & Dollys 26-30
- └ Pulling Clamps 31-33
- └ Car Lifts & Dollys 34-37
- └ Panel Stands & Parts Racks 38-41
- └ Floor Rack 42-44
- └ Tapes & Masking 45-47
- └ Mixing Cups & Liners 48-49
- └ Filters 50-52
- └ Spray Booth 53
- └ Dust Extraction 54-56
- └ Plastic Repair 57
- └ Dent Puller 58-61
- └ Spot Welder & MIG's 62-63
- └ Infrared & UVA LED Paint Curing Systems 64-67
- └ Tool Cabinets & Workbenches 68-71
- └ Solvent - Recyclers 72-75
- └ Solvent - Spray Gun & Pot Cleaners 76-78
- └ Waterborne - Recyclers, Waterborne - Spray Gun & Pot Cleaners 78-81
- └ Matrix Wand 82
- └ Wheel Aligner 83
- └ Bumper Sensor Kits 84-85
- └ Andreae 86
- └ Bossauto 87-88
- └ Etalon 89-91
- └ Fy-Tech 92-94
- └ Induction 95
- └ Meguro 96
- └ MWM 97
- └ Planit 98-101
- └ Stucchi 102
- └ Uniram 103-104



**Car Body Repair System**  
**SKU: FY-9018**

- Advanced international car body repair technology
- Quick repair for various car body metal sheets
- Aluminium repair unit is available as an option
- Luxury trolley, practical and convenient
- Professional spot welding machine with LCD display
- Power supply of 200-400V 50/60Hz 30A
- Pneumatic cupule with 80-120Psi suction pressure
- High quality tools made using the molding process
- Various special repair tools are available as options
- Various repair tools can be hung on the pegboard.



**Dent Puller Complete**  
**SKU: FY-91G**

Microprocessor control system optimizes the welding parameters. Due to the adoption of advanced digital control technology and humanization design, all you have to do is select the welding current corresponding to the workpiece thickness to achieve the best weld quality.  
Automatic mains voltage monitoring, Over-heat protection, Welding gun testing function to evaluate the operating status of welder more completely, Suitable for dent pulling of different kinds of car steels such as conventional steel, stainless steel, etc.  
High precision time adjustment system, Equipped with single-sided spot gun.  
Various welding procedures are available such as shrinking, washer, direct-pulling, OT washer, triangle washer, etc. Digital graphic LCD display, Step-less current regulation.



## Dent Pullers

- └ Abrasives & Cleaning 2-5
- └ Polishing 6-10
- └ Air Tools 11-15
- └ Compressors & Dryers 16-17
- └ Power Tools 18-25
- └ Hand Tools & Dollies 26-30
- └ Pulling Clamps 31-33
- └ Car Lifts & Dollies 34-37
- └ Panel Stands & Parts Racks 38-41
- └ Floor Rack 42-44
- └ Tapes & Masking 45-47
- └ Mixing Cups & Liners 48-49
- └ Filters 50-52
- └ Spray Booth 53
- └ Dust Extraction 54-56
- └ Plastic Repair 57
- └ Dent Puller 58-61
- └ Spot Welder & MIG's 62-63
- └ Infrared & UVA LED Paint Curing Systems 64-67
- └ Tool Cabinets & Workbenches 68-71
- └ Solvent - Recyclers 72-75
- └ Solvent - Spray Gun & Pot Cleaners 76-78
- └ Waterborne - Recyclers, Waterborne - Spray Gun & Pot Cleaners 78-81
- └ Matrix Wand 82
- └ Wheel Aligner 83
- └ Bumper Sensor Kits 84-85
- └ Andreae 86
- └ Bossauto 87-88
- └ Etalon 89-91
- └ Fy-Tech 92-94
- └ Induction 95
- └ Meguro 96
- └ MWM 97
- └ Planit 98-101
- └ Stucchi 102
- └ Uniram 103-104



**13 Piece Auto Body Repair Set Dent Puller**  
SKU: BLP072-022

Designed to remove dents from bodywork. 10lb malleable steel slide hammer. With a solid steel shaft and knurled handle for sure grip. Drop forged and heat treated steel hooks, pullers and attachments.

5 Piece Hasp Iron, 1 Handle, Washer, Long Tube, Hasp Iron, Cast Iron Hammer, Right Angle Flat Steel, Hex Taping Adapter, Hex Taping Screw, Holder, Taping Screw, Connector Hasp Iron & Double Barreled Connector.

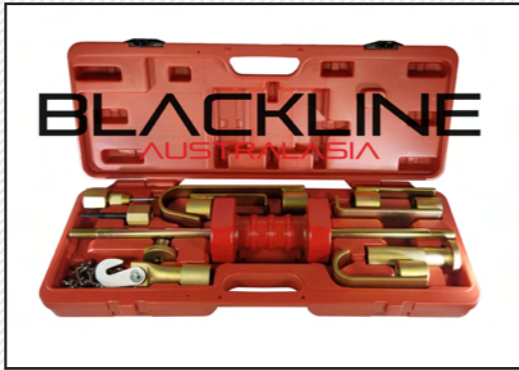

**12lb Slide Hammer Set**  
SKU: BLP072-021

For those hard-to-get-at places on unit-sized body reconstruction, when working on fenders, rocker panels, door edges, bumper ends, aligning doors, hoods, trunks, etc. Hammers both ways without reversing. solid 5/8" steel slide shaft, pipe end nose adapter is machined and plated.

Screw, Adapter, Door Edge Tool, Nose Piece, Straight Driver, Hammer and Shaft, Claw, Short Hook, Deep Hook, Hook and Chain



**Dent Pulling Spot Hammer**  
SKU: FYF003

Can be used with various dent pulling systems.



**Quick Puller**  
SKU: FYF051

Can be used with various dent pulling systems.



**Wavy Wire / Wiggle Wire**  
SKU: FYF006

Can be used with various dent pulling systems.



## Dent Pullers

- └ Abrasives & Cleaning 2-5
- └ Polishing 6-10
- └ Air Tools 11-15
- └ Compressors & Dryers 16-17
- └ Power Tools 18-25
- └ Hand Tools & Dollies 26-30
- └ Pulling Clamps 31-33
- └ Car Lifts & Dollies 34-37
- └ Panel Stands & Parts Racks 38-41
- └ Floor Rack 42-44
- └ Tapes & Masking 45-47
- └ Mixing Cups & Liners 48-49
- └ Filters 50-52
- └ Spray Booth 53
- └ Dust Extraction 54-56
- └ Plastic Repair 57
- └ Dent Puller 58-61
- └ Spot Welder & MIG's 62-63
- └ Infrared & UVA LED Paint Curing Systems 64-67
- └ Tool Cabinets & Workbenches 68-71
- └ Solvent - Recyclers 72-75
- └ Solvent - Spray Gun & Pot Cleaners 76-78
- └ Waterborne - Recyclers, Waterborne - Spray Gun & Pot Cleaners 78-81
- └ Matrix Wand 82
- └ Wheel Aligner 83
- └ Bumper Sensor Kits 84-85
- └ Andreae 86
- └ Bossauto 87-88
- └ Etalon 89-91
- └ Fy-Tech 92-94
- └ Induction 95
- └ Meguro 96
- └ MWM 97
- └ Planit 98-101
- └ Stucchi 102
- └ Uniram 103-104

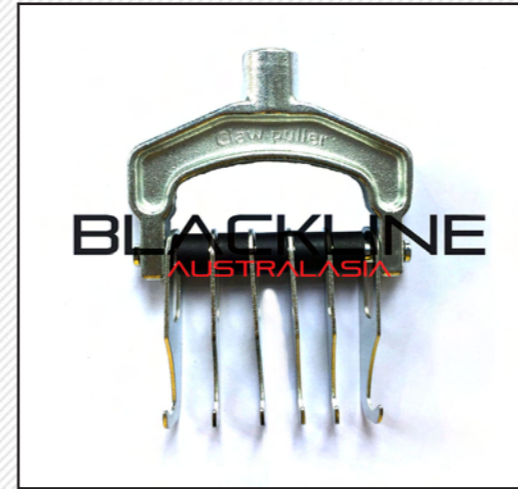

**Pulling Claw**  
SKU: FYF014

Claw attachment for pulling wiggle/wavy wire



**PDR Line Board**  
SKU: PILBL

The PDR Line Board dent removal tool will assist in spotting and fixing dents on painted panels.



**OT Washer Pack**  
SKU: FYF030  
Pack of 20



**Star Triangle Washer**  
SKU: FYF015  
Pack of 10



**10mm Welding Washers**  
SKU: FYF017A  
Pack of 100



**6mm Stud**SKU: FYF016  
Pack of 50



**Electrode Holder**  
SKU: FYF012



**Triangle Washer Connector**  
SKU: FYF013



**Carbon Rod**  
SKU: FYF007



**Carbon Rod Holder**  
SKU: FYF019



**Wavy Wire Tip**  
SKU: FYF010





Spot Welders & MIG's

- └ Abrasives & Cleaning 2 - 5
- └ Polishing 6 -10
- └ Air Tools 11-15
- └ Compressors & Dryers 16-17
- └ Power Tools 18-25
- └ Hand Tools & Dollys 26-30
- └ Pulling Clamps 31-33
- └ Car Lifts & Dollys 34-37
- └ Panel Stands & Parts Racks 38-41
- └ Floor Rack 42-44
- └ Tapes & Masking 45-47
- └ Mixing Cups & Liners 48-49
- └ Filters 50-52
- └ Spray Booth 53
- └ Dust Extraction 54-56
- └ Plastic Repair 57
- └ Dent Puller 58-61
- └ Spot Welder & MIG's 62-63
- └ Infrared & UVA LED Paint Curing Systems 64-67
- └ Tool Cabinets & Workbenches 68-71
- └ Solvent - Recyclers 72-75
- └ Solvent - Spray Gun & Pot Cleaners 76-78
- └ Waterborne - Recyclers, Waterborne - Spray Gun & Pot Cleaners 78-81
- └ Matrix Wand 82
- └ Wheel Aligner 83
- └ Bumper Sensor Kits 84-85
- └ Andreae 86
- └ Bossauto 87-88
- └ Etalon 89-91
- └ Fy-Tech 92-94
- └ Induction 95
- └ Meguro 96
- └ MWM 97
- └ Planit 98-101
- └ Stucchi 102
- └ Uniram 103-104



**Portable IGBT Inverter MIG Welder**  
SKU: FYMIG180

IGBT Inverter and soft switching control technology allows for energy efficient steady welding with fast arc ignition. Materials mechanical properties are maintained with less welding deformation and spatter. User can quickly and easily weld car bodies with various materials and achieve a perfect performance, There is also less post welding treatment work and less welding sparks.

With a multifunctional digital display panel and the most advanced DSP control technology. It features one button intelligent design to automatically track equipment information and to select the welding modes for various materials like steel and stainless steel. The user can store the welding parameters easily and safely.

Technical Data	BLZMIG180
Input voltage±10%	220V
Rated input power	5KVA
Rated input current	8.3A
Min—Max	30A/15.2V-180A/28V
Duty cycle	135A/100%-180A/65%
No-load output voltage	50V
Efficiency	≥90%
Power factor	≥0.95
Insulation grade	F
Frequency	60-120KHz
Steel wire diameter	Φ0.6-0.8mm
Wire feeder	Two-roll drive
	Main machine 43x28x32cm
Main machine	13kg



**Cobalt-Titanium Spot Weld Drill Bit 8mm**  
SKU: BOS050085

Cobalt and titanium spot weld drill bit for working with spot weld drill. Ø 8 mm, short.

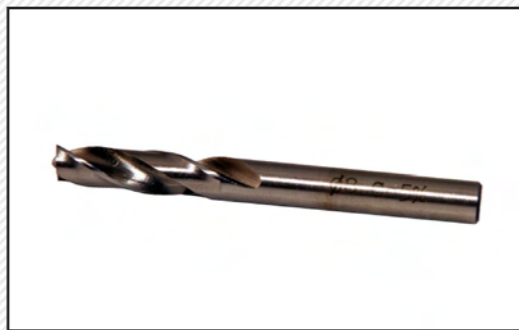

**Cobalt Spot Weld Drill Bit 8mm**  
SKU: BOS050081

Cobalt spot weld drill bit for drilling work. Ø 8 mm, long.



**Inverter Spot Welder 16DC**  
SKU: FY-16DC

FY-16DC air-cooled spot welder adopts the most advanced SEMIKRON IGBT inverter with dual full bridge soft switching circuit technology providing quality spot welds with all new high-strength steels.

The spotter features a large 5" LCD monitor and PET hot press formed control panel that is capable of displaying welding material, time, power and thickness of various welding modes. Easy to learn how to use. Sophisticated circuitry ensures the highest accuracy in reading data.

The core components are imported from European premium brands to enhance overall performance and for quality assurance. FY-16DC inverter stop welder with double-sided C-type gun keeps you in pace with the world.



**Spot Weld Drill Bit 8mm**  
SKU: BLP5P269A

8mmx 45mm

Input voltage: AC 380V 50/60Hz	
Input power: 30KVA	
Input current: 32A	
Max welding current: 16000A	86
Max output power: 80KVA	87-88
1side welding thickness: 1.0+1.5mm	89-91
2side welding thickness: 3.0+3.0+3.0mm	92-94
Max spot weld nugget: 7mm	95
Operation way: Electronic timer continuity(Multi-pulsed)	96
Inverter frequency: 2000Hz	97
Welding time: 0-700ms(Multi-pulsed)	98-101



Spot Welders & MIG's

- └ Abrasives & Cleaning 2 - 5
- └ Polishing 6 -10
- └ Air Tools 11-15
- └ Compressors & Dryers 16-17
- └ Power Tools 18-25
- └ Hand Tools & Dollys 26-30
- └ Pulling Clamps 31-33
- └ Car Lifts & Dollys 34-37
- └ Panel Stands & Parts Racks 38-41
- └ Floor Rack 42-44
- └ Tapes & Masking 45-47
- └ Mixing Cups & Liners 48-49
- └ Filters 50-52
- └ Spray Booth 53
- └ Dust Extraction 54-56
- └ Plastic Repair 57
- └ Dent Puller 58-61
- └ Spot Welder & MIG's 62-63
- └ Infrared & UVA LED Paint Curing Systems 64-67
- └ Tool Cabinets & Workbenches 68-71
- └ Solvent - Recyclers 72-75
- └ Solvent - Spray Gun & Pot Cleaners 76-78
- └ Waterborne - Recyclers Waterborne - Spray Gun & Pot Cleaners 78-81
- └ Matrix Wand 82
- └ Wheel Aligner 83
- └ Bumper Sensor Kits 84-85
- └ Andreae 86
- └ Bossauto 87-88
- └ Etalon 89-91
- └ Fy-Tech 92-94
- └ Induction 95
- └ Meguro 96
- └ MWM 97
- └ Planit 98-101
- └ Stucchi 102
- └ Uniram 103-104



## Infrared Paint Curing Systems

- └ Abrasives & Cleaning 2 - 5
- └ Polishing 6 -10
- └ Air Tools 11-15
- └ Compressors & Dryers 16-17
- └ Power Tools 18-25
- └ Hand Tools & Dollies 26-30
- └ Pulling Clamps 31-33
- └ Car Lifts & Dollies 34-37
- └ Panel Stands & Parts Racks 38-41
- └ Floor Rack 42-44
- └ Tapes & Masking 45-47
- └ Mixing Cups & Liners 48-49
- └ Filters 50-52
- └ Spray Booth 53
- └ Dust Extraction 54-56
- └ Plastic Repair 57
- └ Dent Puller 58-61
- └ Spot Welder & MIG's 62-63
- └ Infrared & UVA LED Paint Curing Systems 64-67
- └ Tool Cabinets & Workbenches 68-71
- └ Solvent - Recyclers 72-75
- └ Solvent - Spray Gun & Pot Cleaners 76-78
- └ Waterborne - Recyclers, Waterborne - Spray Gun & Pot Cleaners 78-81
- └ Matrix Wand 82
- └ Wheel Aligner 83
- └ Bumper Sensor Kits 84-85
- └ Andreae 86
- └ Bossauto 87-88
- └ Etalon 89-91
- └ Fy-Tech 92-94
- └ Induction 95
- └ Meguro 96
- └ MWM 97
- └ Planit 98-101
- └ Stucchi 102
- └ Uniram 103-104

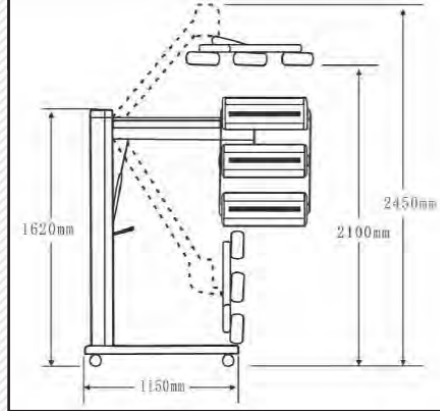

**Infrared 3W Short Wave 3 Bar & Infrared 2AT Shortwave High Reach 2 Bar**  
 SKU: FY-3W                      SKU: FY-2AT

FY-3W Curing Area: 1200x1000mm  
 FY-2AT Curing Area: 800x1000mm

FY-3W & FY-2AT control system is made with the PET hot press molding technique to provide stability and durability and features a touch-key panel design. It can be adjusted according to different paint layer requirements. Each emitter can be independently controlled.

The cassette structure is precision designed and uses 304 grade bright stainless steel reflectors and VPOWER gold plated shortwave infrared halogen lamps that enable the light to distribute evenly and increase the curing area.

Made from aluminium alloy and 304 grade bright stainless steel reflectors. Equipped with Vpower's 21" quartz short wave infrared halogen lamps (Optional PHILIPS lamps also available).

Automatic device with LED display electronic timer and power settings. Hydraulic lifter with an independent switch and 360° rotation. With pulse ultrasonic paint curing function. Power supply 200-240V, 50/60Hz and 1100W lamp tubes. Adjustable temperature range of 40°C – 100°C. Adjustable timer of 0min-99mins. Automatic overload protection. Each emitter can be independently controlled.

## Infrared Paint Curing Systems

- └ Abrasives & Cleaning 2 - 5
- └ Polishing 6 -10
- └ Air Tools 11-15
- └ Compressors & Dryers 16-17
- └ Power Tools 18-25
- └ Hand Tools & Dollies 26-30
- └ Pulling Clamps 31-33
- └ Car Lifts & Dollies 34-37
- └ Panel Stands & Parts Racks 38-41
- └ Floor Rack 42-44
- └ Tapes & Masking 45-47
- └ Mixing Cups & Liners 48-49
- └ Filters 50-52
- └ Spray Booth 53
- └ Dust Extraction 54-56
- └ Plastic Repair 57
- └ Dent Puller 58-61
- └ Spot Welder & MIG's 62-63
- └ Infrared & UVA LED Paint Curing Systems 64-67
- └ Tool Cabinets & Workbenches 68-71
- └ Solvent - Recyclers 72-75
- └ Solvent - Spray Gun & Pot Cleaners 76-78
- └ Waterborne - Recyclers, Waterborne - Spray Gun & Pot Cleaners 78-81
- └ Matrix Wand 82
- └ Wheel Aligner 83
- └ Bumper Sensor Kits 84-85
- └ Andreae 86
- └ Bossauto 87-88
- └ Etalon 89-91
- └ Fy-Tech 92-94
- └ Induction 95
- └ Meguro 96
- └ MWM 97
- └ Planit 98-101
- └ Stucchi 102
- └ Uniram 103-104

**2H Infrared Short Wave 2 Bar Low Reach**  
 SKU: FY-3H

- Curing Area: 800x800mm
- Temperature: 30 – 100°C
- Time Setting: 0- 60min (Adjustable)
- Overall Dimensions: 580x500x1600mm
- Input Power: AC200-240V 50/60Hz
- Power: 2x1000W
- Made from aluminium alloy and 304 grade bright stainless steel reflectors.
- VPOWER quartz shortwave infrared halogen lamps with a life of 5000-7000 hrs (Optional PHILIPS lamps also available).
- Easy to operate, simple mechanical control dial for setting curing time according to requirements.
- Extrusion molded aluminium alloy locking system that is adjustable for strength and convenience.
- Industrially safe -1-1" shape stand that allows the unit to be placed in any position, including between the car wheels, for curing.
- Caster wheels with two-way brakes.
- With an advanced control and display system, the curing time and temperature can be accurately set.
- Cassette is able to move up and down and rotate 360°.



**2W INFRARED S/WAVE 2BAR**  
 SKU: FY-2W

- Curing Area: 800 x 800
- Temperature: 40°C – 75°C
- Timer: 0 – 60mins Adjustable
- Single Phase
- Light Intensity: 100%
- Input Power: 2 x 1100W
- Power Supply: 220V 50/60Hz



**Handheld Infrared Curing Lamp**  
 SKU: FY-1000WS

- Curing Area: 800 x 450mm
- Temperature: 30 – 100°
- Time Setting: 0 – 60min
- Power: 1000W
- Overall Stand Dimensions: 580 x 500 x 1600mm
- Input power: AC200-240V, 50/60Hz



**UVA LED Paint Curing Systems**

- └ Abrasives & Cleaning 2 - 5
- └ Polishing 6 -10
- └ Air Tools 11-15
- └ Compressors & Dryers 16-17
- └ Power Tools 18-25
- └ Hand Tools & Dollys 26-30
- └ Pulling Clamps 31-33
- └ Car Lifts & Dollys 34-37
- └ Panel Stands & Parts Racks 38-41
- └ Floor Rack 42-44
- └ Tapes & Masking 45-47
- └ Mixing Cups & Liners 48-49
- └ Filters 50-52
- └ Spray Booth 53
- └ Dust Extraction 54-56
- └ Plastic Repair 57
- └ Dent Puller 58-61
- └ Spot Welder & MIG's 62-63
- └ Infrared & UVA LED Paint Curing Systems 64-67**
- └ Tool Cabinets & Workbenches 68-71
- └ Solvent - Recyclers 72-75
- └ Solvent - Spray Gun & Pot Cleaners 76-78
- └ Waterborne - Recyclers, Waterborne - Spray Gun & Pot Cleaners 78-81
- └ Matrix Wand 82
- └ Wheel Aligner 83
- └ Bumper Sensor Kits 84-85
- └ Andreae 86
- └ Bossauto 87-88
- └ Etalon 89-91
- └ Fy-Tech 92-94
- └ Induction 95
- └ Meguro 96
- └ MWM 97
- └ Planit 98-101
- └ Stucchi 102
- └ Uniram 103-104



**LIHTAN R4 UVA LED**  
Ultraviolet Curing System

**SKU: R4**

Power Voltage: 220VAC Single phase 1.5amps  
 Electrical Power: 200W (50W per Cassette)  
 Total LED power: 140W (35W per cassette)  
 Curing Area: 500mm x 1300mm  
 Emitting Zone: 1000mm x 400mm  
 Average Irradiance: 14mW/cm<sup>2</sup>  
 Peak Irradiance: 17mW/cm<sup>2</sup>  
 LED: 395nm UVA  
 LED expected lifespan: 30,000+ hours  
 Control: Advanced multifunctional digital control system

**Handheld**

Direct power supply from main control board  
 Curing Area: 350mm x 350mm  
 Power Cable: Extendable 6m cable



**LIHTAN R2 UVA LED**  
Ultraviolet Curing System

**SKU: R2**

Power Voltage: 220VAC Single phase 1.5amps  
 Electrical Power: 100W (50W per Cassette)  
 Total LED power: 70W (35W per cassette)  
 Curing Area: 500mm x 650mm  
 Emitting Zone: 500mm x 400mm  
 Average Irradiance: 14mW/cm<sup>2</sup>  
 Peak Irradiance: 17mW/cm<sup>2</sup>  
 LED: 395nm UVA  
 LED expected lifespan: 30,000+ hours  
 Control: Advanced multifunctional digital control system

**Handheld**

Direct power supply from main control board  
 Curing Area: 350mm x 350mm  
 Power Cable: Extendable 6m cable

Designed by paint technicians for paint technicians, Lihtan's R2 one stop curing system with the latest in high-intensity UV-A LED's provide more curing power and are safer than traditional Mercury lamps.

Lihtan's ground breaking modular design allows you to upgrade from the standard R2 unit to an R3, R4, or R6 unit to increase the size of your curing area.

Requiring no warm up time the unit powers up to maximum curing intensity, instantly.

Manufactured for all current supply voltages and frequencies, it features low power consumption.

Built in distance sensor removes the hassle of manually measuring the position of your work and ensures you get the highest curing intensity every time.

Comes with built in UV block out shade and work table.



**UVA LED Paint Curing Systems**

- └ Abrasives & Cleaning 2 - 5
- └ Polishing 6 -10
- └ Air Tools 11-15
- └ Compressors & Dryers 16-17
- └ Power Tools 18-25
- └ Hand Tools & Dollys 26-30
- └ Pulling Clamps 31-33
- └ Car Lifts & Dollys 34-37
- └ Panel Stands & Parts Racks 38-41
- └ Floor Rack 42-44
- └ Tapes & Masking 45-47
- └ Mixing Cups & Liners 48-49
- └ Filters 50-52
- └ Spray Booth 53
- └ Dust Extraction 54-56
- └ Plastic Repair 57
- └ Dent Puller 58-61
- └ Spot Welder & MIG's 62-63
- └ Infrared & UVA LED Paint Curing Systems 64-67**
- └ Tool Cabinets & Workbenches 68-71
- └ Solvent - Recyclers 72-75
- └ Solvent - Spray Gun & Pot Cleaners 76-78
- └ Waterborne - Recyclers Waterborne - Spray Gun & Pot Cleaners 78-81
- └ Matrix Wand 82
- └ Wheel Aligner 83
- └ Bumper Sensor Kits 84-85
- └ Andreae 86
- └ Bossauto 87-88
- └ Etalon 89-91
- └ Fy-Tech 92-94
- └ Induction 95
- └ Meguro 96
- └ MWM 97
- └ Planit 98-101
- └ Stucchi 102
- └ Uniram 103-104

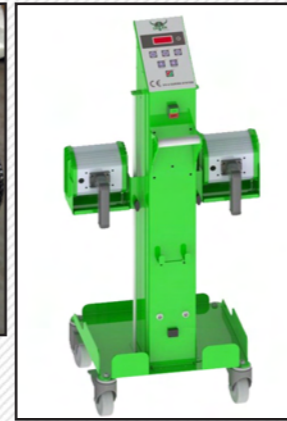
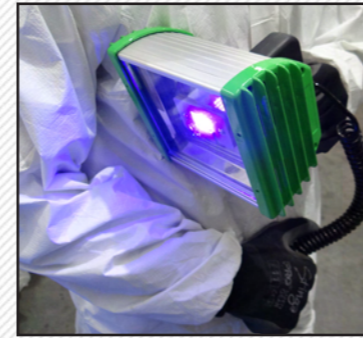

**Mini 1**  
UVA LED Ultraviolet Curing System  
SKU: Mini1

Curing Area: 350mm x 350mm  
 Power Cable: Extendable 6m cable  
 Average Irradiance: 14mW/cm<sup>2</sup>  
 Peak Irradiance: 17mW/cm<sup>2</sup>  
 LED: 395nm UVA  
 LED expected lifespan: 30,000+ hours  
 Control: Advanced multifunctional digital control system  
 Direct power supply from main control board

**SKU: +1 Kit**

A +1 Kit is also available to upgrade the Mini1 into a Mini1+1

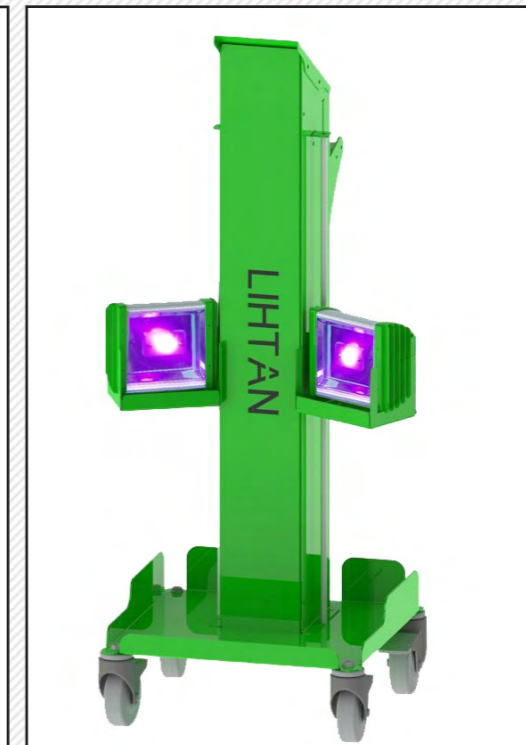

**Mini 1+1**  
UVA LED Ultraviolet Curing System  
SKU: Mini1+1

Curing Area: 350mm x 700mm  
 Power Cable: Extendable 6m cable  
 Average Irradiance: 14mW/cm<sup>2</sup>  
 Peak Irradiance: 17mW/cm<sup>2</sup>  
 LED: 395nm UVA  
 LED expected lifespan: 30,000+ hours  
 Control: Advanced multifunctional digital control system  
 Direct power supply from main control board



## Tool Cabinets & Workbenches

- └ Abrasives & Cleaning 2-5
- └ Polishing 6-10
- └ Air Tools 11-15
- └ Compressors & Dryers 16-17
- └ Power Tools 18-25
- └ Hand Tools & Dollies 26-30
- └ Pulling Clamps 31-33
- └ Car Lifts & Dollies 34-37
- └ Panel Stands & Parts Racks 38-41
- └ Floor Rack 42-44
- └ Tapes & Masking 45-47
- └ Mixing Cups & Liners 48-49
- └ Filters 50-52
- └ Spray Booth 53
- └ Dust Extraction 54-56
- └ Plastic Repair 57
- └ Dent Puller 58-61
- └ Spot Welder & MIG's 62-63
- └ Infrared & UVA LED Paint Curing Systems 64-67
- └ Tool Cabinets & Workbenches 68-71
- └ Solvent - Recyclers 72-75
- └ Solvent - Spray Gun & Pot Cleaners 76-78
- └ Waterborne - Recyclers, Waterborne - Spray Gun & Pot Cleaners 78-81
- └ Matrix Wand 82
- └ Wheel Aligner 83
- └ Bumper Sensor Kits 84-85
- └ Andreae 86
- └ Bossauto 87-88
- └ Etalon 89-91
- └ Fy-Tech 92-94
- └ Induction 95
- └ Meguro 96
- └ MWM 97
- └ Planit 98-101
- └ Stucchi 102
- └ Uniram 103-104



**3 Layer Parts Cart**  
SKU: BLPTY-05

Can mount panels and bumpers of any size and shape allowing easy access to both sides.



**BLACKLINE AUSTRALASIA**  
**Trolley**  
SKU: FY-9B-TROLLEY

Can be used to position and hold your work piece at a comfortable angle while you work on it.



**BLZ-800VS**

**Workbench**  
SKU: FY-800VS

1570 x 700 x 800mm

Heavy-duty steel structure with loading capacity of 500kg. Made from 304 grade stainless steel tabletop, incredibly strong and durable.



**BLZ-800ESH**

**Workbench with Pegboard**  
SKU: FY-800ESH

1512 x 812 x 1430mm

Heavy-duty steel structure with loading capacity of 500kg. Erosion and corrosion resistant. Made from 304 grade stainless steel tabletop, incredibly strong and durable. Comes complete with pegboard.



**Workbench with Pegboard and Draws**  
SKU: FY-800ESH

1500 x 750 x 1475mm

Heavy-duty steel structure with loading capacity of 500kg. Erosion and corrosion resistant. Made from 304 grade stainless steel tabletop, incredibly strong and durable. Comes complete with pegboard.



## Tool Cabinets & Workbenches

- └ Abrasives & Cleaning 2-5
- └ Polishing 6-10
- └ Air Tools 11-15
- └ Compressors & Dryers 16-17
- └ Power Tools 18-25
- └ Hand Tools & Dollies 26-30
- └ Pulling Clamps 31-33
- └ Car Lifts & Dollies 34-37
- └ Panel Stands & Parts Racks 38-41
- └ Floor Rack 42-44
- └ Tapes & Masking 45-47
- └ Mixing Cups & Liners 48-49
- └ Filters 50-52
- └ Spray Booth 53
- └ Dust Extraction 54-56
- └ Plastic Repair 57
- └ Dent Puller 58-61
- └ Spot Welder & MIG's 62-63
- └ Infrared & UVA LED Paint Curing Systems 64-67
- └ Tool Cabinets & Workbenches 68-71
- └ Solvent - Recyclers 72-75
- └ Solvent - Spray Gun & Pot Cleaners 76-78
- └ Waterborne - Recyclers, Waterborne - Spray Gun & Pot Cleaners 78-81
- └ Matrix Wand 82
- └ Wheel Aligner 83
- └ Bumper Sensor Kits 84-85
- └ Andreae 86
- └ Bossauto 87-88
- └ Etalon 89-91
- └ Fy-Tech 92-94
- └ Induction 95
- └ Meguro 96
- └ MWM 97
- └ Planit 98-101
- └ Stucchi 102
- └ Uniram 103-104



**Tool Station**

All storage compartments are lockable. Available in the pictured combinations. See next page.

All Tool Stations come with a Large Peg Board with set of air and power connection sockets.

\*Please note: Due to the large size of these Tool Stations they must be pre-ordered.



- └ Abrasives & Cleaning 2-5
- └ Polishing 6-10
- └ Air Tools 11-15
- └ Compressors & Dryers 16-17
- └ Power Tools 18-25
- └ Hand Tools & Dollies 26-30
- └ Pulling Clamps 31-33
- └ Car Lifts & Dollies 34-37
- └ Panel Stands & Parts Racks 38-41
- └ Floor Rack 42-44
- └ Tapes & Masking 45-47
- └ Mixing Cups & Liners 48-49
- └ Filters 50-52
- └ Spray Booth 53
- └ Dust Extraction 54-56
- └ Plastic Repair 57
- └ Dent Puller 58-61
- └ Spot Welder & MIG's 62-63
- └ Infrared & UVA LED Paint Curing Systems 64-67
- └ Tool Cabinets & Workbenches 68-71
- └ Solvent - Recyclers 72-75
- └ Solvent - Spray Gun & Pot Cleaners 76-78
- └ Waterborne - Recyclers, Waterborne - Spray Gun & Pot Cleaners 78-81
- └ Matrix Wand 82
- └ Wheel Aligner 83
- └ Bumper Sensor Kits 84-85
- └ Andreae 86
- └ Bossauto 87-88
- └ Etalon 89-91
- └ Fy-Tech 92-94
- └ Induction 95
- └ Meguro 96
- └ MWM 97
- └ Planit 98-101
- └ Stucchi 102
- └ Uniram 103-104



- 2-5 Abrasives & Cleaning
- 6-10 Polishing
- 11-15 Air Tools
- 16-17 Compressors & Dryers
- 18-25 Power Tools
- 26-30 Hand Tools & Dollies
- 31-33 Pulling Clamps
- 34-37 Car Lifts & Dollies
- 38-41 Panel Stands & Parts Racks
- 42-44 Floor Rack
- 45-47 Tapes & Masking
- 48-49 Mixing Cups & Liners
- 50-52 Filters
- 53 Spray Booth
- 54-56 Dust Extraction
- 57 Plastic Repair
- 58-61 Dent Puller
- 62-63 Spot Welder & MIG's
- 64-67 Infrared & UVA LED Paint Curing Systems
- 68-71 Tool Cabinets & Workbenches
- 72-75 Solvent - Recyclers
- 76-78 Solvent - Spray Gun & Pot Cleaners
- 78-81 Waterborne - Recyclers Waterborne - Spray Gun & Pot Cleaners
- 82 Matrix Wand
- 83 Wheel Aligner
- 84-85 Bumper Sensor Kits
- 86 Andreae
- 87-88 Bossauto
- 89-91 Etalon
- 92-94 Fy-Tech
- 95 Induction
- 96 Meguro
- 97 MWM
- 98-101 Planit
- 102 Stucchi
- 103-104 Uniram

All storage compartments are lockable. Available in the pictured combinations.

All tool stations come with a large peg board with set of air and power connection sockets.

\*Please Note: Due to the large size of these tool stations they must be pre-ordered.

### Tool Stations

- 210x72x210cm SKU: FY-7730A
- 300x72x210cm SKU: FY-7740A
- 370x72x210cm SKU: FY-7750A
- 440x72x210cm SKU: FY-7780A
- 510x72x210cm SKU: FY-7770A
- 580x72x210cm SKU: FY-7790A

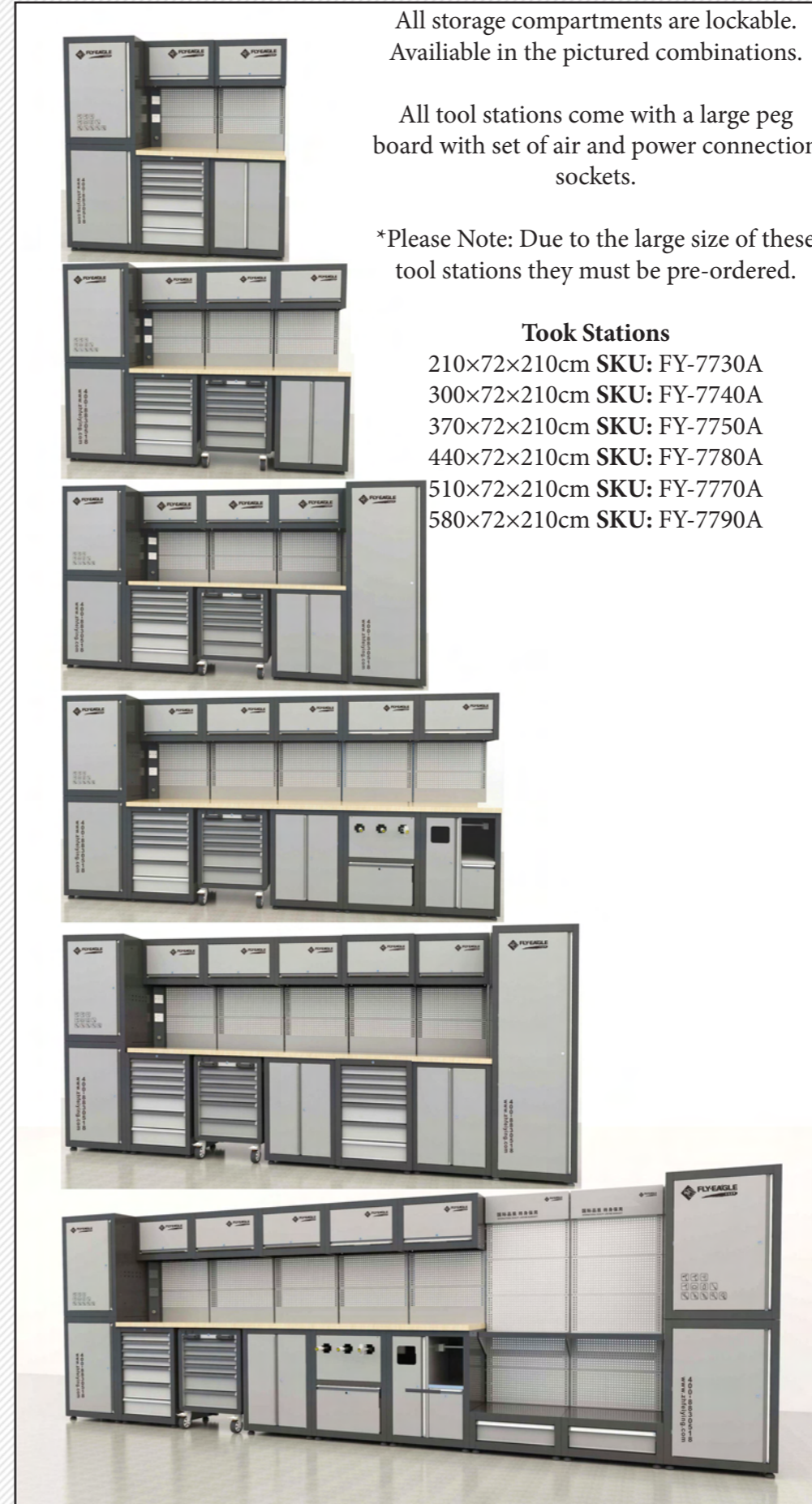

Solvent Recyclers

- └ Abrasives & Cleaning 2-5
- └ Polishing 6-10
- └ Air Tools 11-15
- └ Compressors & Dryers 16-17
- └ Power Tools 18-25
- └ Hand Tools & Dollies 26-30
- └ Pulling Clamps 31-33
- └ Car Lifts & Dollies 34-37
- └ Panel Stands & Parts Racks 38-41
- └ Floor Rack 42-44
- └ Tapes & Masking 45-47
- └ Mixing Cups & Liners 48-49
- └ Filters 50-52
- └ Spray Booth 53
- └ Dust Extraction 54-56
- └ Plastic Repair 57
- └ Dent Puller 58-61
- └ Spot Welder & MIG's 62-63
- └ Infrared & UVA LED Paint Curing Systems 64-67
- └ Tool Cabinets & Workbenches 68-71
- └ Solvent - Recyclers 72-75**
- └ Solvent - Spray Gun & Pot Cleaners 76-78
- └ Waterborne - Recyclers, Waterborne - Spray Gun & Pot Cleaners 78-81
- └ Matrix Wand 82
- └ Wheel Aligner 83
- └ Bumper Sensor Kits 84-85
- └ Andreae 86
- └ Bossauto 87-88
- └ Etalon 89-91
- └ Fy-Tech 92-94
- └ Induction 95
- └ Meguro 96
- └ MWM 97
- └ Planit 98-101
- └ Stucchi 102
- └ Uniram 103-104

**STANDARD OPERATING FEATURES - ALL MODELS**

- Distillation by vaporization and condensation
- Polished stainless steel, corrosive resistant cabinet for years of dependable service
- Automatic shut off
- Sealed electric heating element with heavy-duty insulation
- High efficiency condenser, air cooled with motor driven fan
- Complete with 3 disposable tank liner bags and 1 lid gasket
- Direct heating - low maintenance with no heating oil to dispose of

**SOLVENT REQUIREMENTS**

- Distillation temperature between 50° and 200° C (140°F and 392° F)
- Safety caution: Not for use with esters of nitrocellulose often found in wood stains
- Ignition point above 260°C (446°F)

**DISTILLATION PROCESS EASY TO USE.**

1. Transfer dirty solvent to the distillation tank of the recycler.
2. Press START; the heater vaporizes the solvent. Residue remains in a heat resistant liner bag in the tank.
3. Clean solvent vapor cools as it flows through the condenser to the clean solvent pail.
4. Transfer clean solvent from the recycler.

**DISTILLATION TANK OF A SOLVENT RECYCLER WITH SAFETY FEATURES.**

**CONTROL SYSTEM:** A sophisticated micro processor continuously monitors and controls the work flow.

**Self-diagnostics.**

**SAFETY:** Certified to UL Standard 2208 and CSA Standard 22.2 No. 30 and 88.

For use in nonhazardous locations and hazardous location Class 1 Division 1; Group D. A facility such as a Collision Repair Shop, by NEC, is a class 1, Division 1 environment in the mixing room and Class 1, Division 2 in the shop. Uni-ram recyclers are approved for use in such facilities.

Popular models are internationally approved:

IECEx BAS11.0057  
Baseefa 11ATEX0118 CE1180  
Ex d ib IIA T2 Gb

**Over 10,000 companies in over 20 countries have purchased Uni-ram solvent recyclers to reclaim used solvent, minimizing the generation of hazardous waste and lowering operating cost. Customers include dealerships of all major car manufacturers, Boeing Corporation, paint manufacturers such as Sherwin Williams, Standox and PPG. Demand for Uni-ram recyclers will continue to grow as users and environmental agencies focus on ways to reduce hazardous waste.**

LISTED  
CERTIFIED TO  
CSA C22.2 No. 30

LISTED  
CONFORMS TO  
UL Standard No. 2208

73

**BLACKLINE**  
AUSTRALASIA

Solvent Recyclers

- 2-5 Abrasives & Cleaning
- 6-10 Polishing
- 11-15 Air Tools
- 16-17 Compressors & Dryers
- 18-25 Power Tools
- 26-30 Hand Tools & Dollies
- 31-33 Pulling Clamps
- 34-37 Car Lifts & Dollies
- 38-41 Panel Stands & Parts Racks
- 42-44 Floor Rack
- 45-47 Tapes & Masking
- 48-49 Mixing Cups & Liners
- 50-52 Filters
- 53 Spray Booth
- 54-56 Dust Extraction
- 57 Plastic Repair
- 58-61 Dent Puller
- 62-63 Spot Welder & MIG's
- 64-67 Infrared & UVA LED Paint Curing Systems
- 68-71 Tool Cabinets & Workbenches
- 72-75 Solvent - Recyclers**
- 76-78 Solvent - Spray Gun & Pot Cleaners
- 78-81 Waterborne - Recyclers Waterborne - Spray Gun & Pot Cleaners
- 82 Matrix Wand
- 83 Wheel Aligner
- 84-85 Bumper Sensor Kits
- 86 Andreae
- 87-88 Bossauto
- 89-91 Etalon
- 92-94 Fy-Tech
- 95 Induction
- 96 Meguro
- 97 MWM
- 98-101 Planit
- 102 Stucchi
- 103-104 Uniram

UNIRAM solvent recyclers effectively reclaim used solvent by segregating the waste residue in a bag in the distillation tank.

The clean, distilled solvent can be used over and over with virtually no loss of cleaning power. Typical solvents are paint thinner, gun wash solvent, acetone and MEK. Unique hardened aluminium tank construction provides excellent heat transfer.

With a UNIRAM recycler unnecessary solvent purchases are eliminated; purchases drop by up to 90%. Waste disposal costs drop by up to 95% Profitability improves.

**URS400TSN – Mini Solvent Recycler**  
**SKU: URS400TSN**

The URS400TSN Mini Table Top Solvent Recycler purifies dirty solvent through distillation.

- Capacity 9.5 Liters
- Lowers solvent purchase & disposal costs by 90%
- Sealed direct electric element requires no oil
- Intrinsically safe computer controls with six temperature settings and automatic shut-off
- Certified for unattended use and for operation in Class One Division One areas
- Stainless steel construction with hardened aluminium tank
- Power: 220-240V
- Dimensions: 15 x 15 x 26.5" WDH

**URS600 – Solvent Recycler**  
**SKU: URS400TSN**

Capacity: 20 L  
Speed: 4-6 hrs

The URS600 effectively reclaims used solvent. The clean, distilled solvent can be used over and over. Typical solvents are paint thinner, gun wash solvent, acetone and MEK. With a URS600, unnecessary solvent purchases are eliminated; purchases drop by 90% and waste disposal costs drop by 90%. Profitability improves.

Power Supply: 230-240 V, 1500 W heater  
Display: LEDs indicate heating and cooling phase  
Microprocessor : Controls work flow. Self diagnostics.  
Dimensions: w 43cm x d 43cm x h 107cm – 59 kg

**URS600 – Solvent Recycler**  
**SKU: URS400TSN**

- Tank Capacity: 5.0 US Gal (20 liters)
- Speed: 5.0 US Gal in about 4 hours
- Solvent Transfer: Auto-transfer, In and Out

Powered by heavy-duty diaphragm pump, timer automatically transfers 5 gal of dirty solvent into the recycler tank and a timer transfers clean solvent from the recycler. Includes 5 gal pail and transfer hoses.

- Air Pressure: 75-85 PSI, unit complete with pressure regulator and filter
- Power Supply: 220/240V, 1500W, 6.5A
- Display: LEDs indicate power on, heat on and 6 temperature set points
- Heater: 1500W

**Solvent Recyclers**

- └ Abrasives & Cleaning 2 - 5
- └ Polishing 6 - 10
- └ Air Tools 11-15
- └ Compressors & Dryers 16-17
- └ Power Tools 18-25
- └ Hand Tools & Dollys 26-30
- └ Pulling Clamps 31-33
- └ Car Lifts & Dollys 34-37
- └ Panel Stands & Parts Racks 38-41
- └ Floor Rack 42-44
- └ Tapes & Masking 45-47
- └ Mixing Cups & Liners 48-49
- └ Filters 50-52
- └ Spray Booth 53
- └ Dust Extraction 54-56
- └ Plastic Repair 57
- └ Dent Puller 58-61
- └ Spot Welder & MIG's 62-63
- └ Infrared & UVA LED Paint Curing Systems 64-67
- └ Tool Cabinets & Workbenches 68-71
- └ Solvent - Recyclers 72-75
- └ Solvent - Spray Gun & Pot Cleaners 76-78
- └ Waterborne - Recyclers, Waterborne - Spray Gun & Pot Cleaners 78-81
- └ Matrix Wand 82
- └ Wheel Aligner 83
- └ Bumper Sensor Kits 84-85
- └ Andreae 86
- └ Bossauto 87-88
- └ Etalon 89-91
- └ Fy-Tech 92-94
- └ Induction 95
- └ Meguro 96
- └ MWM 97
- └ Planit 98-101
- └ Stucchi 102
- └ Uniram 103-104

**URS900**  
**SKU: UNIS900**  
Mid-Size, 240V

- Tank Capacity: 5 US Gal (20 litres)
- Speed: 5 US Gal in about 4-6 hours
- Solvent Transfer: Manual transfer
- Air Pressure: Not applicable
- Power Supply: 220/240V, 2200W, 9.3A
- Heater: 2100W

• Enhanced Control Features & Digital Display

Easy settings for:

- dryer waste residue
- automatic or timed heater shut-off
- maximum temperature °C set point
- regulation of the rate of recycling using heating power percentage



UNIRAM solvent recyclers effectively reclaim used solvent by segregating the waste residue in a bag in the distillation tank.

The clean, distilled solvent can be used over and over with virtually no loss of cleaning power.

Typical solvents are paint thinner, gun wash solvent, acetone and MEK. Unique hardened aluminium tank construction provides excellent heat transfer.

With a UNIRAM recycler unnecessary solvent purchases are eliminated; purchases drop by up to 90%. Waste disposal costs drop by up to 95% Profitability improves.



**COMBO656 – RECY/ GUNWASH/600 & UG6000**  
**SKU: UNICOMBO656-CE**

- Automatic and manual cleaning with both a flow-through brush for the outside of the guns and a wash nozzle for the inside.
- Hose Cleaning: Hose is flushed with Wash Solvent, Air, Clean Solvent and Air again, all in less than 60 seconds.
- Level Gauge for Clean Solvent Pail indicates time to recycle
- Durable, rust free, stainless construction for years of service
- Recycles 19 litres in about 4 hours
- Faster cook time with hardened aluminum tank
- Continue to clean spray guns while solvent is recycling
- Complete with corrosive resistant pails
- Large wash tank – 20" W x 17" D x 15" H

**Solvent Recyclers**

- └ Abrasives & Cleaning 2 - 5
- └ Polishing 6 - 10
- └ Air Tools 11-15
- └ Compressors & Dryers 16-17
- └ Power Tools 18-25
- └ Hand Tools & Dollys 26-30
- └ Pulling Clamps 31-33
- └ Car Lifts & Dollys 34-37
- └ Panel Stands & Parts Racks 38-41
- └ Floor Rack 42-44
- └ Tapes & Masking 45-47
- └ Mixing Cups & Liners 48-49
- └ Filters 50-52
- └ Spray Booth 53
- └ Dust Extraction 54-56
- └ Plastic Repair 57
- └ Dent Puller 58-61
- └ Spot Welder & MIG's 62-63
- └ Infrared & UVA LED Paint Curing Systems 64-67
- └ Tool Cabinets & Workbenches 68-71
- └ Solvent - Recyclers 72-75
- └ Solvent - Spray Gun & Pot Cleaners 76-78
- └ Waterborne - Recyclers, Waterborne - Spray Gun & Pot Cleaners 78-81
- └ Matrix Wand 82
- └ Wheel Aligner 83
- └ Bumper Sensor Kits 84-85
- └ Andreae 86
- └ Bossauto 87-88
- └ Etalon 89-91
- └ Fy-Tech 92-94
- └ Induction 95
- └ Meguro 96
- └ MWM 97
- └ Planit 98-101
- └ Stucchi 102
- └ Uniram 103-104

**URS900EP2 with Auto Transfer**  
**SKU: UNIS900EP2**

- Tank Capacity: 5 US Gal (20 litres)
- Speed: 5 US Gal in about 4-6 hours
- Solvent Transfer: Auto-transfer, in and out
- Air Pressure: Min 85 PSI, unit complete with pressure regulator and filter
- Power Supply: 220/240V, 2200W, 9.3A
- Heater: 2100W

• Enhanced Control Features and Digital Display

Easy settings for:

- dryer waste residue
- automatic or timed heater shut-off
- maximum temperature set points in °F or °C
- regulation of the rate of recycling using heating power percentage



UNIRAM solvent recyclers effectively reclaim used solvent by segregating the waste residue in a bag in the distillation tank.

The clean, distilled solvent can be used over and over with virtually no loss of cleaning power.

Typical solvents are paint thinner, gun wash solvent, acetone and MEK. Unique hardened aluminium tank construction provides excellent heat transfer.

With a UNIRAM recycler unnecessary solvent purchases are eliminated; purchases drop by up to 90%. Waste disposal costs drop by up to 95% Profitability improves.



**URS2000SS – 80litre Tank 240V**  
**SKU: UNIS2000SS**

- Tank Capacity: 20 US Gal (80 litres), Stainless Steel
- Speed: 20 US Gal in about 8-10 hours
- Solvent Transfer: Auto-transfer, in and out
- Air Pressure: Min 85 PSI, unit complete with pressure regulator and filter
- Power Supply: 220/240V, 3400W, 20A
- Heater: 3300W

• Enhanced Control Features and Digital Display

Easy settings for:

- dryer waste residue
- automatic or timed heater shut-off
- maximum temperature set points in °C
- regulation of the rate of recycling using heating power percentage



**Solvent Spray Gun & Pot Cleaners**

- └ Abrasives & Cleaning 2 - 5
- └ Polishing 6 -10
- └ Air Tools 11-15
- └ Compressors & Dryers 16-17
- └ Power Tools 18-25
- └ Hand Tools & Dollies 26-30
- └ Pulling Clamps 31-33
- └ Car Lifts & Dollies 34-37
- └ Panel Stands & Parts Racks 38-41
- └ Floor Rack 42-44
- └ Tapes & Masking 45-47
- └ Mixing Cups & Liners 48-49
- └ Filters 50-52
- └ Spray Booth 53
- └ Dust Extraction 54-56
- └ Plastic Repair 57
- └ Dent Puller 58-61
- └ Spot Welder & MIG's 62-63
- └ Infrared & UVA LED Paint Curing Systems 64-67
- └ Tool Cabinets & Workbenches 68-71
- └ Solvent - Recyclers 72-75
- └ Solvent - Spray Gun & Pot Cleaners 76-78
- └ Waterborne - Recyclers, Waterborne - Spray Gun & Pot Cleaners 78-81
- └ Matrix Wand 82
- └ Wheel Aligner 83
- └ Bumper Sensor Kits 84-85
- └ Andreae 86
- └ Bossauto 87-88
- └ Etalon 89-91
- └ Fy-Tech 92-94
- └ Induction 95
- └ Meguro 96
- └ MWM 97
- └ Planit 98-101
- └ Stucchi 102
- └ Uniram 103-104

**COMBO656 – RECY/ GUNWASH/600 & UG6000**  
SKU: UNICOMBO656-CE

- Automatic and manual cleaning with both a flow-through brush for the outside of the guns and a wash nozzle for the inside.
- Hose Cleaning: Hose is flushed with Wash Solvent, Air, Clean Solvent and Air again, all in less than 60 seconds.
- Level Gauge for Clean Solvent Pail indicates time to recycle
- Durable, rust free, stainless construction for years of service
  - Recycles 19 litres in about 4 hours
  - Faster cook time with hardened aluminum tank
  - Continue to clean spray guns while solvent is recycling
  - Complete with corrosive resistant pails
  - Large wash tank – 20" W x 17" D x 15" H



**UM80S – GUN CLEANER SOLVENT WALL MOUNT**  
SKU: UNIUM80S

- **CLEANING BECOMES FAST AND EASY**
- Solvent under high pressure flows, at the press of a button, to thoroughly clean the paint passage in less than 30 seconds.
- The outside of the gun can be cleaned with a Flowthrough Brush and dried with a Blow Gun (both included).
- Locating the compact UM80S inside the spray booth saves time because the gun can remain connected to the air line and the painter can remain in the booth; the paint channel is flushed while the paint is still "wet".
  - For use with solvent based paints only.
  - For use in the spray booth or in the general shop area.
  - Ideal for cleaning PPS and other disposable cup adapters.
- Cleaning tools – nozzle for cleaning paint passage, pad to clean cap, flow-through brush to clean exterior of gun and blow gun to dry paint passage and exterior.
  - Non-corrosive stainless steel cleaning tank.
  - Powered by Uni-ram's dual diaphragm pump.



**UG110 – GUN CLEANER 1 GUN AUTO**  
SKU: UNIUG110

- Guns & Pots Cleaned: One
- No. of Swirl Action Jets: 6
- Tank Size: 17.25 x 1.5 x 14.25" (WDH)

**Solvent Spray Gun & Pot Cleaners**

- └ Abrasives & Cleaning 2 - 5
- └ Polishing 6 -10
- └ Air Tools 11-15
- └ Compressors & Dryers 16-17
- └ Power Tools 18-25
- └ Hand Tools & Dollies 26-30
- └ Pulling Clamps 31-33
- └ Car Lifts & Dollies 34-37
- └ Panel Stands & Parts Racks 38-41
- └ Floor Rack 42-44
- └ Tapes & Masking 45-47
- └ Mixing Cups & Liners 48-49
- └ Filters 50-52
- └ Spray Booth 53
- └ Dust Extraction 54-56
- └ Plastic Repair 57
- └ Dent Puller 58-61
- └ Spot Welder & MIG's 62-63
- └ Infrared & UVA LED Paint Curing Systems 64-67
- └ Tool Cabinets & Workbenches 68-71
- └ Solvent - Recyclers 72-75
- └ Solvent - Spray Gun & Pot Cleaners 76-78
- └ Waterborne - Recyclers, Waterborne - Spray Gun & Pot Cleaners 78-81
- └ Matrix Wand 82
- └ Wheel Aligner 83
- └ Bumper Sensor Kits 84-85
- └ Andreae 86
- └ Bossauto 87-88
- └ Etalon 89-91
- └ Fy-Tech 92-94
- └ Induction 95
- └ Meguro 96
- └ MWM 97
- └ Planit 98-101
- └ Stucchi 102
- └ Uniram 103-104



**UG2000D – Two Gun Cleaner with Wash and Pail**  
SKU: UNIUG2000D

- Guns & Pots Cleaned: Two
- No. of Swirl Action Jets: 14
- Tank Size: 17.25 x 1.5 x 14.25" (WDH)



**UG4000D – Two Gun Cleaner with Vent, Clean Rinse and Manual Cleaning Brush**  
SKU: UNIUG4000D

- Two Gun Cleaner with Vent, includes one pail
  - Guns & Pots Cleaned: Two
  - No. of Swirl Action Jets: 14
  - Tank Size: 17.25 x 13.5 x 14.25" (WDH)
- Cleaning Cycle: Wash, Air Flush, Clean Rinse (100cc) and Air Flush
- Manual Cleaning: Flow Through Brush, Clean Solvent flow activated by Foot Pedal

**UG7500E – 2 Gun with Automatic Cleaning Tank & Manual Wash Sink**  
SKU: UNIUG7500E

- State-of-the-Art Cleaning and Ease of Use Enclosed sink and work surface with Hood Door
  - Tank and Sink: Automatic Cleaning Tank & Manual Wash Sink
    - Guns & Pots Cleaned Automatically: Two
      - Hose Cleaning: Optional
      - No. of Swirl Action Jets: 14
    - Tank Size: 17.25 x 13.5 x 14.25" (WDH)
  - Automatic Cleaning Cycle: Wash, Air Flush, Clean Rinse (100cc) and Air Flush, Hands Free Foot Pedal Operation
  - Enhanced Manual Cleaning: Flow Through Brush & Clean Solvent, Flexible, Spigot activated independently by separate Foot Pedals
  - Combo Ready: Yes (for connection to "EP2" Series solvent Recycler)
- Patent No. 4,785,836 in USA. Many Patents in place in other countries

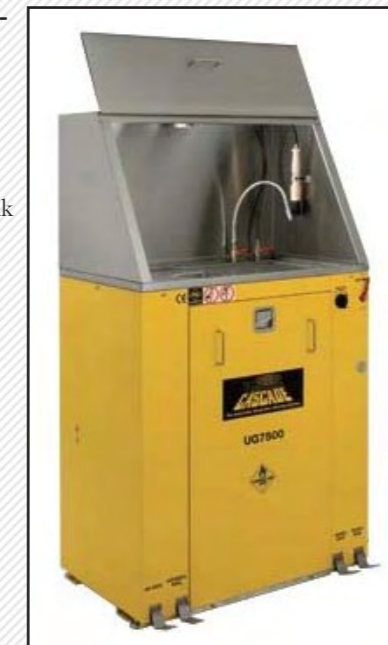



## Waterborne Recyclers & Spray Gun & Pot Cleaners

- └ Abrasives & Cleaning 2-5
- └ Polishing 6-10
- └ Air Tools 11-15
- └ Compressors & Dryers 16-17
- └ Power Tools 18-25
- └ Hand Tools & Dollies 26-30
- └ Pulling Clamps 31-33
- └ Car Lifts & Dollies 34-37
- └ Panel Stands & Parts Racks 38-41
- └ Floor Rack 42-44
- └ Tapes & Masking 45-47
- └ Mixing Cups & Liners 48-49
- └ Filters 50-52
- └ Spray Booth 53
- └ Dust Extraction 54-56
- └ Plastic Repair 57
- └ Dent Puller 58-61
- └ Spot Welder & MIG's 62-63
- └ Infrared & UVA LED Paint Curing Systems 64-67
- └ Tool Cabinets & Workbenches 68-71
- └ Solvent - Recyclers 72-75
- └ Solvent - Spray Gun & Pot Cleaners 76-78
- └ Waterborne - Recyclers, Waterborne - Spray Gun & Pot Cleaners 78-81
- └ Matrix Wand 82
- └ Wheel Aligner 83
- └ Bumper Sensor Kits 84-85
- └ Andreae 86
- └ Bossauto 87-88
- └ Etalon 89-91
- └ Fy-Tech 92-94
- └ Induction 95
- └ Meguro 96
- └ MWM 97
- └ Planit 98-101
- └ Stucchi 102
- └ Uniram 103-104



**UG5000W – GUN CLEANER WATER AND SOLVENT**  
SKU: UG5000W

- CE Approved.
- Complete with pressure regulator. Minimum air pressure is 6 bar (85 psi).
- Dimensions: 119 cm w x 43 cm d x 117 cm h
- Dimensions: 47" w x 17" d x 46" h
- Weight: 77 kg (170 lb)

### SOLVENT-BORNE SPRAY GUN CLEANING (left side)

- Automatic Cleaning
- 14 L (3.7 gal) of wash solvent is pumped through 14 jets to flush the fluid passage and exterior of 2 spray guns in under 1 minute. A final rinse of 100 cc of clean solvent and air flush completes automatic cleaning.
- Automatic Cleaning is faster than cleaning by hand, allowing more cars to be painted each day.
- Automatic Cleaning provides a consistent result as opposed to cleaning by hand.
- Additional manual cleaning, when required, is provided by a flow-through brush. Solvent flow is activated by a foot pedal.
- Automatic cleaning greatly reduces the Painter's exposure to solvent for a healthier environment. Spray guns are cleaned with solvent in an enclosed tank; the operation is "Hands Free". The vent automatically extracts fumes when the lid is raised. If the lid is accidentally raised during cleaning, the operation stops, to prevent solvent exposure.
- Wash solvent is reused until dirty, reducing solvent consumption, a "Green" approach. Wash solvent can also be recycled in a Uni-ram solvent recycler then reused.

### WATERBORNE SPRAY GUN CLEANING (right side)

- Manual Cleaning
- Waterborne spray guns are cleaned effectively with 3 cleaning tools.
- Wash gun delivers high pressure water to flush the fluid passage in under 15 seconds.
- Flow-through brush removes paint from the outside of the spray gun.
- Air gun dries the spray gun.
- The cleaning power of water is enhanced by the addition of AQUA-KLEEN, Uni-ram's cleaner.
- The used water can be recovered and reused reducing waste water consumption and disposal costs, it is a "Green" approach.
- Continue to clean spray guns while solvent is recycling
- Complete with corrosive resistant pails
- Large wash tank – 20" W x 17" D x 15" H



## Waterborne Recyclers & Spray Gun & Pot Cleaners

- └ Abrasives & Cleaning 2-5
- └ Polishing 6-10
- └ Air Tools 11-15
- └ Compressors & Dryers 16-17
- └ Power Tools 18-25
- └ Hand Tools & Dollies 26-30
- └ Pulling Clamps 31-33
- └ Car Lifts & Dollies 34-37
- └ Panel Stands & Parts Racks 38-41
- └ Floor Rack 42-44
- └ Tapes & Masking 45-47
- └ Mixing Cups & Liners 48-49
- └ Filters 50-52
- └ Spray Booth 53
- └ Dust Extraction 54-56
- └ Plastic Repair 57
- └ Dent Puller 58-61
- └ Spot Welder & MIG's 62-63
- └ Infrared & UVA LED Paint Curing Systems 64-67
- └ Tool Cabinets & Workbenches 68-71
- └ Solvent - Recyclers 72-75
- └ Solvent - Spray Gun & Pot Cleaners 76-78
- └ Waterborne - Recyclers, Waterborne - Spray Gun & Pot Cleaners 78-81
- └ Matrix Wand 82
- └ Wheel Aligner 83
- └ Bumper Sensor Kits 84-85
- └ Andreae 86
- └ Bossauto 87-88
- └ Etalon 89-91
- └ Fy-Tech 92-94
- └ Induction 95
- └ Meguro 96
- └ MWM 97
- └ Planit 98-101
- └ Stucchi 102
- └ Uniram 103-104



**AQUA KLEEN**  
SKU: UNI102-8200

AQUA-KLEEN PGC is used with a manual or automatic spray gun cleaner to effectively wash waterborne paint from spray guns.

### Benefits

- Spray guns clean faster with AQUA-KLEEN PGC. The non-corrosive cleaning solution effectively cuts and dissolves paint enhancing the cleaning power of water and significantly reducing the cleaning effort.
- Productivity increases as the cleaning power of the AQUA-KLEEN PGC solution lasts much longer than water alone. Many shops effectively clean spray guns with the same solution for 3 months or more before reclaiming or replacing the solution.
- When dirty the AQUA-KLEEN PGC solution can be reclaimed for reuse using Uni-ram's COAG-KLEEN FP flocculant powder and filter system.
- AQUA-KLEEN PGC is shipped as a concentrate not a solution; light weight and compact size results in lower freight costs.
- When mixed as directed, VOC content is 25 grams or less per L; thereby compliant with SCAQMD rule 102/ 1171 in California.
- Rust inhibiting

**COAG KLEEN 2KG**  
SKU: UNI102-8300

- COAG-KLEEN FP, flocculant, removes the absorbed waste paint solids from water that has been used to clean spray guns. The clean recovered water can be reused several times before disposal. The separated paint waste, when dry, is then disposed of in accordance with local regulations

### Benefits

- Lower disposal costs since the water can be reused several times before disposal. Shop operation becomes "Greener".
- Lower operating costs. Less flocculant used, at 2 scoops per 5 gal (20 L), compared to competitive flocculants.
- Uni-ram's COAG-KLEEN FP has a coarse granular consistency; very little powder goes airborne providing the operator with a clean air environment.

**UM120W – GUN CLEANER WATER BASE**  
SKU: UNIUM120W

- Wash gun delivers high pressure water to clean the paint channel.
- Flow-through brush removes paint from the outside of the gun.
- Air gun dries the spray gun and a spray out verifies a clean paint channel.
- The "GREEN" Water Recovery System features filtering after treatment with Uni-ram's flocculating agent, COAGKLEEN FP. Recovered clean water may be disposed of or reused, minimizing water consumption
- For use with waterborne paints only.
- Patent No. 4,785,836 in USA. Many Patents in place in other countries
- Powered by Uni-ram's dual diaphragm pump.
- Air supply whip line included.

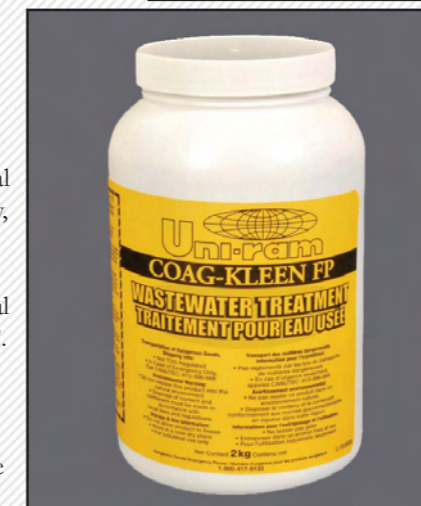
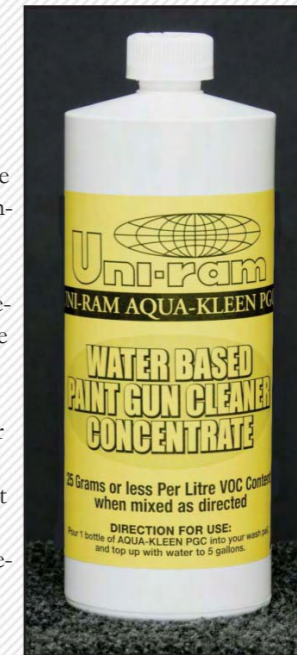

Waterborne Recyclers & Spray Gun & Pot Cleaners

- └ Abrasives & Cleaning 2 - 5
- └ Polishing 6 -10
- └ Air Tools 11-15
- └ Compressors & Dryers 16-17
- └ Power Tools 18-25
- └ Hand Tools & Dollies 26-30
- └ Pulling Clamps 31-33
- └ Car Lifts & Dollies 34-37
- └ Panel Stands & Parts Racks 38-41
- └ Floor Rack 42-44
- └ Tapes & Masking 45-47
- └ Mixing Cups & Liners 48-49
- └ Filters 50-52
- └ Spray Booth 53
- └ Dust Extraction 54-56
- └ Plastic Repair 57
- └ Dent Puller 58-61
- └ Spot Welder & MIG's 62-63
- └ Infrared & UVA LED Paint Curing Systems 64-67
- └ Tool Cabinets & Workbenches 68-71
- └ Solvent - Recyclers 72-75
- └ Solvent - Spray Gun & Pot Cleaners 76-78
- └ Waterborne - Recyclers, Waterborne - Spray Gun & Pot Cleaners 78-81**
- └ Matrix Wand 82
- └ Wheel Aligner 83
- └ Bumper Sensor Kits 84-85
- └ Andreae 86
- └ Bossauto 87-88
- └ Etalon 89-91
- └ Fy-Tech 92-94
- └ Induction 95
- └ Meguro 96
- └ MWM 97
- └ Planit 98-101
- └ Stucchi 102
- └ Uniram 103-104



**UW300 – Spray Gun Cleaner Work Station**  
SKU: UNI UW300

The work station meets all of a painter's spray gun cleaning requirements. The manual station better accommodates the manual cleaning process of disassembling the spray gun and cleaning the components. The funnel and waste pail conveniently collect waste paint. Stepping on the foot pedal dispenses an adjustable flow of cleaning liquid into the tray, minimizing waste. Components of the spray gun are cleaned in the tray using the provided cleaning tools. The parts are dried with a blow gun. The unique, recessed wash system machine cleans one spray gun automatically in 1 minute. There is a wash, rinse and air rinse cycle. Using the automatic system saves time. After 12 cleanings, the painter gains an hour for more painting.

**Manual Station**

- The nozzle, activated by a foot pedal, dispenses liquid into the tray for cleaning.
- The gun is disassembled and components are put into the tray (11.6" w x 6.0" d x 2.0" h).
  - 18 tools are available for cleaning.
  - The blow gun dries the components.
- There is ample space to reassemble the spray gun.

**Automatic Station**

- Cleans one spray gun in about 2 minutes.
- Cleaning cycle consists of wash, air flush, clean rinse, air rinse.
- Liquid streams from nozzles and swirl action jets to wash paint from the spray gun.
- Air plug with positive air pressure prevents liquid from entering the air passage of spray gun.
  - Blow gun dries the spray gun.
  - Tank size: 12.5" w x 12.0" d x 13.5" h

**Sludge Station**

- Waste paint can be poured into the sludge pail through a 4" funnel on the table.

**Work Station Features:**

- The table top, cleaning tray and automatic tank are constructed from corrosive resistant stainless steel for long life and easy cleaning.
  - Dual 4" diaphragm pump (3 cfm), pressure regulator at 85 psi.
  - 2 non corrosive HDPE pails to hold wash solvent and clean rinse solvent.
- Options:
  - Vent Tube at back of automatic cleaning tank to extract fumes when lid is raised, part number 143-6130

Waterborne Recyclers & Spray Gun & Pot Cleaners

- └ Abrasives & Cleaning 2 - 5
- └ Polishing 6 -10
- └ Air Tools 11-15
- └ Compressors & Dryers 16-17
- └ Power Tools 18-25
- └ Hand Tools & Dollies 26-30
- └ Pulling Clamps 31-33
- └ Car Lifts & Dollies 34-37
- └ Panel Stands & Parts Racks 38-41
- └ Floor Rack 42-44
- └ Tapes & Masking 45-47
- └ Mixing Cups & Liners 48-49
- └ Filters 50-52
- └ Spray Booth 53
- └ Dust Extraction 54-56
- └ Plastic Repair 57
- └ Dent Puller 58-61
- └ Spot Welder & MIG's 62-63
- └ Infrared & UVA LED Paint Curing Systems 64-67
- └ Tool Cabinets & Workbenches 68-71
- └ Solvent - Recyclers 72-75
- └ Solvent - Spray Gun & Pot Cleaners 76-78
- └ Waterborne - Recyclers Waterborne - Spray Gun & Pot Cleaners 78-81**
- └ Matrix Wand 82
- └ Wheel Aligner 83
- └ Bumper Sensor Kits 84-85
- └ Andreae 86
- └ Bossauto 87-88
- └ Etalon 89-91
- └ Fy-Tech 92-94
- └ Induction 95
- └ Meguro 96
- └ MWM 97
- └ Planit 98-101
- └ Stucchi 102
- └ Uniram 103-104



**UM80W – GUN CLEANER WATER BASE MANUAL**  
SKU: UNIU M80W

- Compact wall mount unit designed for quick color changes with an optional stand for free standing installation
- Uses high pressure water to clean the paint channel in less than 30 seconds at the press of a button.
- Flow-through brush removes paint from the outside of the gun.
- Air Blow Gun dries the spray gun and a spray out verifies a clean paint channel.
  - Also includes Cap Brush and whip line
- Ideal for cleaning PPS and other disposable cup adapters

Locating the unit inside the spray booth saves time; the gun can remain connected to the air supply and the painter can remain in the booth; the paint channel is flushed while the paint is still wet.

- Air supply whip line included.

**UM80WF – Gun Cleaner Water Base Wall Mount**  
SKU: UNIU M80WF



**WALL MOUNT SPRAY GUN CLEANER WITH WASTE WATER TREATMENT BY FLOCCULATION, CLEANING BECOMES FAST AND EASY**

- Water under high pressure flows, at the press of a button, to thoroughly clean the paint passage in less than 30 seconds.
- The outside of the gun is cleaned with the Flow-through Brush and dried with the included Blow Gun.
- Locating the compact UM80WF inside the spray booth saves time because the gun can remain connected to the air line and the painter can remain in the booth; the paint channel is flushed while the paint is still "wet".
- After cleaning, treat dirty water by Flocculation and Filtering to recover clean water for reuse.
  - For use with waterborne paints only.
  - For use in the spray booth or in the general shop area.
  - For use with water only or with Uni-ram's effective cleaner, AQUA-KLEEN PGC, Part No. 102-8200, (1L concentrate)
    - Use Uni-ram's COAG-KLEEN, Part No. 102-8300, coarse-grain flocculant granules for efficient flocculation without messy airborne contamination.
- Ideal for cleaning PPS and other disposable cup adapters.

**FEATURES**

- Waste water treatment system built in.
- Cleaning tools – nozzle for cleaning paint passage, pad to clean cap, flow-through brush to clean exterior of gun and blow gun to dry paint passage and exterior.
  - Air supply whip line included.
- Non-corrosive stainless steel cleaning tank.
- Powered by Uni-ram's dual diaphragm pump.



## The Matrix Wand - Vehicle Measuring System

- └ Abrasives & Cleaning 2-5
- └ Polishing 6-10
- └ Air Tools 11-15
- └ Compressors & Dryers 16-17
- └ Power Tools 18-25
- └ Hand Tools & Dollies 26-30
- └ Pulling Clamps 31-33
- └ Car Lifts & Dollies 34-37
- └ Panel Stands & Parts Racks 38-41
- └ Floor Rack 42-44
- └ Tapes & Masking 45-47
- └ Mixing Cups & Liners 48-49
- └ Filters 50-52
- └ Spray Booth 53
- └ Dust Extraction 54-56
- └ Plastic Repair 57
- └ Dent Puller 58-61
- └ Spot Welder & MIG's 62-63
- └ Infrared & UVA LED Paint Curing Systems 64-67
- └ Tool Cabinets & Workbenches 68-71
- └ Solvent - Recyclers 72-75
- └ Solvent - Spray Gun & Pot Cleaners 76-78
- └ Waterborne - Recyclers, Waterborne - Spray Gun & Pot Cleaners 78-81
- └ Matrix Wand 82
- └ Wheel Aligner 83
- └ Bumper Sensor Kits 84-85
- └ Andreae 86
- └ Bossauto 87-88
- └ Etalon 89-91
- └ Fy-Tech 92-94
- └ Induction 95
- └ Meguro 96
- └ MWM 97
- └ Planit 98-101
- └ Stucchi 102
- └ Uniram 103-104

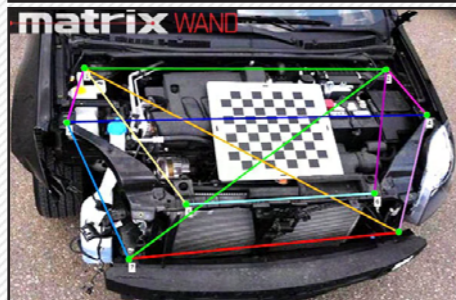

### Matrix Wand Measuring System SKU: Matrix Wand

The Matrix Wand is the tool of choice for body shop professionals to quickly identify hidden damage and improve work flow through the shop. Prior to the Matrix Wand, blueprinting each vehicle that arrived in the shop was time consuming and often cost prohibitive. Tearing down each car to find hidden damage consumes valuable time on the frame machine, labor, and shop floor space. Within a matter of minutes every car that goes through the shop can be measured to identify hidden damage to: Ensure accurate estimates the first time to reduce supplements while increasing efficiency and profitability throughout the repair process. Blueprint the work to be carried out and the parts required. Verify the repair by comparing points to the Mitchell Database integrated into Matrix's Software. Provide documentation to insurance companies and customers to improve customer satisfaction and reduce liability.

#### STEP 1 – IMAGE THE VEHICLE

Use the target-less handheld Matrix Wand to take 3D images of the vehicle with minimal tear down.

#### STEP 2 – CAPTURE THE DATA

Use Matrix's proprietary data collection software to download the 3D images and data points to your computer. This process is quick and easy giving you the ability to capture visible and hidden damage on the fly.

#### STEP 3 – MEASURE FAST AND ACCURATELY

Use the Repair Analysis Software to start measuring any point on the vehicle: Zoom in on the 3D image and select any point you would like to measure. Estimate and repair more accurately by identifying "damage" areas versus "trusted" areas or utilize the integrated Mitchell Database to compare points to factory specifications.

#### STEP 4 – DOCUMENT AND BLUEPRINT

Document damage to share with insurance companies and customers. Blueprint the job to assure work is carried out and parts ordered with the greatest efficiency.

#### STEP 5 – REPAIR AND VERIFY

Carry out the repair and use the Matrix Wand to assist with accuracy. This includes sensor angle positioning, hanging doors, verifying alignment, and checking suspension. Capture a final measurement to verify the car is repaired back to specification and document to minimize liability.

## 3D Wheel Aligner

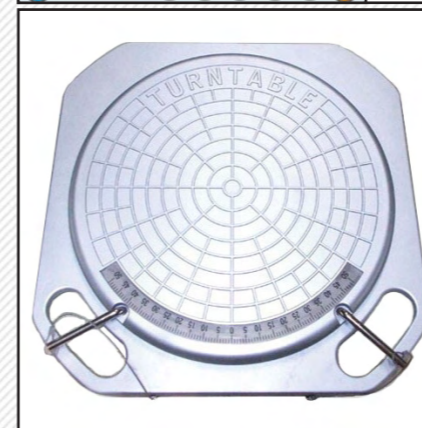

### 3D Wheel Aligner SKU: FY-WheelAligner

Titanium Alloy Turntables  
Aluminium Alloy Target Clamps fit 12 to 24 inch rims  
5mega Pixel HD PureCel Image Sensors with Nyxel Technology

1. **Super Short Installation Distance:** 80CM from cameras beam to front edge of lift. (80CM-2700MM, from cameras beam to front edge of scissor lift)
2. **Super Short Push Car Operation:** Less 10CM
3. **KEED Cloud Network**  
It allow service engineer to take control of aligner remotely, routine hardware checking & maintenance guidance, adding new vehicle data, adjusting camera gains to code with actual brightness on site, and alignment operation assistance, etc.
4. **Tire Wearing Indication**  
The unique feature indicates the actual diameters of the four wheels. Therefore, advise for changing tire or which tires can be provided to car owner without dismantling the tires from the vehicle.

- 2-5 Abrasives & Cleaning
- 6-10 Polishing
- 11-15 Air Tools
- 16-17 Compressors & Dryers
- 18-25 Power Tools
- 26-30 Hand Tools & Dollies
- 31-33 Pulling Clamps
- 34-37 Car Lifts & Dollies
- 38-41 Panel Stands & Parts Racks
- 42-44 Floor Rack
- 45-47 Tapes & Masking
- 48-49 Mixing Cups & Liners
- 50-52 Filters
- 53 Spray Booth
- 54-56 Dust Extraction
- 57 Plastic Repair
- 58-61 Dent Puller
- 62-63 Spot Welder & MIG's
- 64-67 Infrared & UVA LED Paint Curing Systems
- 68-71 Tool Cabinets & Workbenches
- 72-75 Solvent - Recyclers
- 76-78 Solvent - Spray Gun & Pot Cleaners
- 78-81 Waterborne - Recyclers Waterborne - Spray Gun & Pot Cleaners
- 82 Matrix Wand
- 83 Wheel Aligner
- 84-85 Bumper Sensor Kits
- 86 Andreae
- 87-88 Bossauto
- 89-91 Etalon
- 92-94 Fy-Tech
- 95 Induction
- 96 Meguro
- 97 MWM
- 98-101 Planit
- 102 Stucchi
- 103-104 Uniram

**Bumper Sensor Kit**

- └ Abrasives & Cleaning 2-5
- └ Polishing 6-10
- └ Air Tools 11-15
- └ Compressors & Dryers 16-17
- └ Power Tools 18-25
- └ Hand Tools & Dollies 26-30
- └ Pulling Clamps 31-33
- └ Car Lifts & Dollies 34-37
- └ Panel Stands & Parts Racks 38-41
- └ Floor Rack 42-44
- └ Tapes & Masking 45-47
- └ Mixing Cups & Liners 48-49
- └ Filters 50-52
- └ Spray Booth 53
- └ Dust Extraction 54-56
- └ Plastic Repair 57
- └ Dent Puller 58-61
- └ Spot Welder & MIG's 62-63
- └ Infrared & UVA LED Paint Curing Systems 64-67
- └ Tool Cabinets & Workbenches 68-71
- └ Solvent - Recyclers 72-75
- └ Solvent - Spray Gun & Pot Cleaners 76-78
- └ Waterborne - Recyclers, Waterborne - Spray Gun & Pot Cleaners 78-81
- └ Matrix Wand 82
- └ Wheel Aligner 83
- └ **Bumper Sensor Kits 84-85**
- └ Andreae 86
- └ Bossauto 87-88
- └ Etalon 89-91
- └ Fy-Tech 92-94
- └ Induction 95
- └ Meguro 96
- └ MWM 97
- └ Planit 98-101
- └ Stucchi 102
- └ Uniram 103-104



**15 Piece Drill Kit for Parking Sensors**  
SKU: MWM30603

Kit Includes:

- 16mm
- 17mm
- 18mm
- 18.5mm
- 19mm
- 20mm
- 21mm
- 22mm
- 23mm
- 24mm
- 26mm
- 27mm
- 28mm
- 30mm
- 32mm

Helical Drilling Tip HSS  
Diameter 8.5mm

Assembling parking sensors on a new bumper?

This drill kit makes it easy to drill the perfect size hole for the job and avoid costly mistakes when using a step drill bit.

MWM offers a complete kit with appropriate tooling inclusive of drills for diameters 16/17/18/18.5/19/20/21/22/23/24/26/27/28/30/32mm supplied in a handy mini plastic case and relevant use instructions.

Includes Helical Drilling Tip HSS Diameter 8.5mm to drill matching pilot hole.



**Bumper Sensor Kit**

- └ Abrasives & Cleaning 2-5
- └ Polishing 6-10
- └ Air Tools 11-15
- └ Compressors & Dryers 16-17
- └ Power Tools 18-25
- └ Hand Tools & Dollies 26-30
- └ Pulling Clamps 31-33
- └ Car Lifts & Dollies 34-37
- └ Panel Stands & Parts Racks 38-41
- └ Floor Rack 42-44
- └ Tapes & Masking 45-47
- └ Mixing Cups & Liners 48-49
- └ Filters 50-52
- └ Spray Booth 53
- └ Dust Extraction 54-56
- └ Plastic Repair 57
- └ Dent Puller 58-61
- └ Spot Welder & MIG's 62-63
- └ Infrared & UVA LED Paint Curing Systems 64-67
- └ Tool Cabinets & Workbenches 68-71
- └ Solvent - Recyclers 72-75
- └ Solvent - Spray Gun & Pot Cleaners 76-78
- └ Waterborne - Recyclers, Waterborne - Spray Gun & Pot Cleaners 78-81
- └ Matrix Wand 82
- └ Wheel Aligner 83
- └ **Bumper Sensor Kits 84-85**
- └ Andreae 86
- └ Bossauto 87-88
- └ Etalon 89-91
- └ Fy-Tech 92-94
- └ Induction 95
- └ Meguro 96
- └ MWM 97
- └ Planit 98-101
- └ Stucchi 102
- └ Uniram 103-104



**6 Piece Drill Kit for Parking Sensors**  
SKU: MWM30601

Kit Includes

- 17mm
- 18mm
- 19mm
- 20mm
- 21mm
- 22mm

Helical Drilling Tip HSS  
Diameter 8.5mm

Assembling parking sensors on a new bumper?

This drill kit makes it easy to drill the perfect size hole for the job and avoid costly mistakes when using a step drill bit.

MWM offers a complete kit with appropriate tooling inclusive of drills for diameters 17/18/19/20/21/22mm supplied in a handy mini plastic case and relevant use instructions. Includes Helical Drilling Tip HSS Diameter 8.5mm to drill matching pilot hole.



**24mm Drill for Parking Sensors**  
SKU: MWM306240

Assembling parking sensors on a new bumper? This drill kit makes it easy to drill the perfect size hole for the job and avoid costly mistakes when using a step drill bit.



**26mm Drill for Parking Sensors**  
SKU: MWM306260

Assembling parking sensors on a new bumper? This drill kit makes it easy to drill the perfect size hole for the job and avoid costly mistakes when using a step drill bit.



## Andreae Team

- └ Abrasives & Cleaning 2 - 5
- └ Polishing 6 -10
- └ Air Tools 11-15
- └ Compressors & Dryers 16-17
- └ Power Tools 18-25
- └ Hand Tools & Dollys 26-30
- └ Pulling Clamps 31-33
- └ Car Lifts & Dollys 34-37
- └ Panel Stands & Parts Racks 38-41
- └ Floor Rack 42-44
- └ Tapes & Masking 45-47
- └ Mixing Cups & Liners 48-49
- └ Filters 50-52
- └ Spray Booth 53
- └ Dust Extraction 54-56
- └ Plastic Repair 57
- └ Dent Puller 58-61
- └ Spot Welder & MIG's 62-63
- └ Infrared & UVA LED Paint Curing Systems 64-67
- └ Tool Cabinets & Workbenchs 68-71
- └ Solvent - Recyclers 72-75
- └ Solvent - Spray Gun & Pot Cleaners 76-78
- └ Waterborne - Recyclers, Waterborne - Spray Gun & Pot Cleaners 78-81
- └ Matrix Wand 82
- └ Wheel Aligner 83
- └ Bumper Sensor Kits 84-85
- └ Andreae 86
- └ Bossauto 87-88
- └ Etalon 89-91
- └ Fy-Tech 92-94
- └ Induction 95
- └ Meguro 96
- └ MWM 97
- └ Planit 98-101
- └ Stucchi 102
- └ Uniram 103-104



Andreae Team is the inventor and original manufacturer of the accordion style, pleated paper filter for spray booth exhaust filtration. Also known as the organ filter, gopher card, fluted card filter, painter's paper and concertina, Andreae Filters are used around the world in the Liquid Finishing Industry.

Unique in design and working principle, Andreae Filters hold more paint particles than other exhaust filter media while maintaining uniform air flow around the parts being sprayed. This contributes to a cleaner air environment for the worker and the community at large. Andreae Filters are EPA compliant, easy to install and dispose, and last longer than fiberglass, expanded paper, polyester or styro-foam media.

For over fifty years, Andreae Team has produced an economical, efficient alternative to common overspray collection filters. Andreae Filters were revolutionary in 1963 and remain a standout paint arrestor today. As our Team continues to grow, we welcome the opportunity to service your air filtration and paint booth needs.

Andreae Filters and Floor Paper are distributed world wide with a network covering six of seven continents. If you are interested in distributing Andreae products, please contact us for details. If you are interested in purchasing Andreae products for use in your paint booth or finishing line, please contact us for a distributor near you.



Andreae Concertina Filter 90cm SKU: ANDAF813  
 Andreae Concertina Filter 100cm SKU: ANDAF113  
 Andreae Concertina High Efficiency Filter 90cm SKU: ANDAF923



## Bossauto

# BOSSAUTO

Everyday Improving



**Abrasive Sponge Sanding Pads**  
 (115 X 140 X 5mm) FINE – BOS060161  
 (115 X 140 X 5mm) MEDIUM – BOS060160  
 (115 X 140 X 5mm) MICROFINE – BOS060163  
 (115 X 140 X 5mm) SUPERFINE – BOS060162

The composition and size of these abrasive sponges allow access to difficult to access body parts, producing a finer and smoother surface quality.  
 Pack of 20 pads.

### BLACKLINE AUSTRALASIA



Cobalt Spot Weld Drill Bit 8mm  
 SKU: BOS050081

### BLACKLINE AUSTRALASIA



Cobalt-Titanium Spot Weld Drill Bit 8mm  
 SKU: BOS050085

### BLACKLINE AUSTRALASIA



Double Sided Tape for Rear View Mirror  
 SKU: BOS040099

### BLACKLINE AUSTRALASIA



Dust Cutting Metal Blade 3mm  
 SKU: BOS100042

### BLACKLINE AUSTRALASIA



Foam masking tape XFOAM 13mm 50m  
 SKU: BOS100713

### BLACKLINE AUSTRALASIA



Iron Mask (3pack)  
 SKU: BOS100073

- 2 - 5 Abrasives & Cleaning
- 6 -10 Polishing
- 11-15 Air Tools
- 16-17 Compressors & Dryers
- 18-25 Power Tools
- 26-30 Hand Tools & Dollys
- 31-33 Pulling Clamps
- 34-37 Car Lifts & Dollys
- 38-41 Panel Stands & Parts Racks
- 42-44 Floor Rack
- 45-47 Tapes & Masking
- 48-49 Mixing Cups & Liners
- 50-52 Filters
- 53 Spray Booth
- 54-56 Dust Extraction
- 57 Plastic Repair
- 58-61 Dent Puller
- 62-63 Spot Welder & MIG's
- 64-67 Infrared & UVA LED Paint Curing Systems
- 68-71 Tool Cabinets & Workbenchs
- 72-75 Solvent - Recyclers
- 76-78 Solvent - Spray Gun & Pot Cleaners
- 78-81 Waterborne - Recyclers Waterborne - Spray Gun & Pot Cleaners
- 82 Matrix Wand
- 83 Wheel Aligner
- 84-85 Bumper Sensor Kits
- 86 Andreae
- 87-88 Bossauto
- 89-91 Etalon
- 92-94 Fy-Tech
- 95 Induction
- 96 Meguro
- 97 MWM
- 98-101 Planit
- 102 Stucchi
- 103-104 Uniram



## Bossauto

- └ Abrasives & Cleaning 2-5
- └ Polishing 6-10
- └ Air Tools 11-15
- └ Compressors & Dryers 16-17
- └ Power Tools 18-25
- └ Hand Tools & Dollys 26-30
- └ Pulling Clamps 31-33
- └ Car Lifts & Dollys 34-37
- └ Panel Stands & Parts Racks 38-41
- └ Floor Rack 42-44
- └ Tapes & Masking 45-47
- └ Mixing Cups & Liners 48-49
- └ Filters 50-52
- └ Spray Booth 53
- └ Dust Extraction 54-56
- └ Plastic Repair 57
- └ Dent Puller 58-61
- └ Spot Welder & MIG's 62-63
- └ Infrared & UVA LED Paint Curing Systems 64-67
- └ Tool Cabinets & Workbenches 68-71
- └ Solvent - Recyclers 72-75
- └ Solvent - Spray Gun & Pot Cleaners 76-78
- └ Waterborne - Recyclers, Waterborne - Spray Gun & Pot Cleaners 78-81
- └ Matrix Wand 82
- └ Wheel Aligner 83
- └ Bumper Sensor Kits 84-85
- └ Andreae 86
- └ Bossauto 87-88
- └ Etalon 89-91
- └ Fy-Tech 92-94
- └ Induction 95
- └ Meguro 96
- └ MWM 97
- └ Planit 98-101
- └ Stucchi 102
- └ Uniram 103-104



Logotrans

SKU: BOS040065



Stat Gun

SKU: BOSSTATGUN

## BLACKLINE AUSTRALASIA



TechCup Calibrated Mixing Cup 3800ml

SKU: BOS100304



TechCup Glass Lid with Safety Lock 3800ml

SKU: BOS100309



MASK '&' UP 10mm

SKU: BOSS100241



Nylon Sealer Brush

SKU: BOS050003



Putty Knives with Silicone Blade 30cm

SKU: BOS100067



## Etalon

- 2-5 Abrasives & Cleaning
- 6-10 Polishing
- 11-15 Air Tools
- 16-17 Compressors & Dryers
- 18-25 Power Tools
- 26-30 Hand Tools & Dollys
- 31-33 Pulling Clamps
- 34-37 Car Lifts & Dollys
- 38-41 Panel Stands & Parts Racks
- 42-44 Floor Rack
- 45-47 Tapes & Masking
- 48-49 Mixing Cups & Liners
- 50-52 Filters
- 53 Spray Booth
- 54-56 Dust Extraction
- 57 Plastic Repair
- 58-61 Dent Puller
- 62-63 Spot Welder & MIG's
- 64-67 Infrared & UVA LED Paint Curing Systems
- 68-71 Tool Cabinets & Workbenches
- 72-75 Solvent - Recyclers
- 76-78 Solvent - Spray Gun & Pot Cleaners
- 78-81 Waterborne - Recyclers Waterborne - Spray Gun & Pot Cleaners
- 82 Matrix Wand
- 83 Wheel Aligner
- 84-85 Bumper Sensor Kits
- 86 Andreae
- 87-88 Bossauto
- 89-91 Etalon
- 92-94 Fy-Tech
- 95 Induction
- 96 Meguro
- 97 MWM
- 98-101 Planit
- 102 Stucchi
- 103-104 Uniram



## BLACKLINE AUSTRALASIA



Absolute Compound

SKU: ET2010

## BLACKLINE AUSTRALASIA



Absolute Cut Compound

SKU: ET1010

## BLACKLINE AUSTRALASIA



Alligator Catalyst

SKU: ETALIGH025

## BLACKLINE AUSTRALASIA



Alligator Coating Tintable

SKU: ETALIG075

## BLACKLINE AUSTRALASIA



Dry Control Powder

SKU: ETDG-00B

## BLACKLINE AUSTRALASIA



Etalu Aluminium Putty

SKU: ET5300ALU100

## BLACKLINE AUSTRALASIA



Etaplast Putty for Plastics

SKU: ET5300PP100

## BLACKLINE AUSTRALASIA



Etasoft Polyester Putty 2kg

SKU: ET5300UP200

## BLACKLINE AUSTRALASIA



Etasoft Polyester Putty 4kg

SKU: ET5300UP400



## Etalon

- └ Abrasives & Cleaning 2-5
- └ Polishing 6-10
- └ Air Tools 11-15
- └ Compressors & Dryers 16-17
- └ Power Tools 18-25
- └ Hand Tools & Dollys 26-30
- └ Pulling Clamps 31-33
- └ Car Lifts & Dollys 34-37
- └ Panel Stands & Parts Racks 38-41
- └ Floor Rack 42-44
- └ Tapes & Masking 45-47
- └ Mixing Cups & Liners 48-49
- └ Filters 50-52
- └ Spray Booth 53
- └ Dust Extraction 54-56
- └ Plastic Repair 57
- └ Dent Puller 58-61
- └ Spot Welder & MIG's 62-63
- └ Infrared & UVA LED Paint Curing Systems 64-67
- └ Tool Cabinets & Workbenches 68-71
- └ Solvent - Recyclers 72-75
- └ Solvent - Spray Gun & Pot Cleaners 76-78
- └ Waterborne - Recyclers, Waterborne - Spray Gun & Pot Cleaners 78-81
- └ Matrix Wand 82
- └ Wheel Aligner 83
- └ Bumper Sensor Kits 84-85
- └ Andreae 86
- └ Bossauto 87-88
- └ Etalon 89-91
- └ Fy-Tech 92-94
- └ Induction 95
- └ Meguro 96
- └ MWM 97
- └ Planit 98-101
- └ Stucchi 102
- └ Uniram 103-104



Etafine Polyester Putty

SKU: ET5300FP100



Metal Polish

SKU: ETMET930750



Fast Cut Compound 1

SKU: ET1001



Finishing Glaze

SKU: ET1004



Machine Polish III

SKU: ET1003



Top Inspection Spray

SKU: ETTOP007



1K PU Sealant

White SKU: ETPU7200W  
Black SKU: ETPU7200B  
Grey SKU: ETPU7200G



Headlight Repair Kit 3in1

SKU: ETKIT3IN1



Touch-Up Plastic Bottle 2in1

SKU: ETTOUCH21



Underbody Coating Black

SKU: ETUC1000B



Underbody Coating Grey

SKU: ETUC1000G



Underbody Coating White

SKU: ETUC1000W



## Etalon

- └ Abrasives & Cleaning 2-5
- └ Polishing 6-10
- └ Air Tools 11-15
- └ Compressors & Dryers 16-17
- └ Power Tools 18-25
- └ Hand Tools & Dollys 26-30
- └ Pulling Clamps 31-33
- └ Car Lifts & Dollys 34-37
- └ Panel Stands & Parts Racks 38-41
- └ Floor Rack 42-44
- └ Tapes & Masking 45-47
- └ Mixing Cups & Liners 48-49
- └ Filters 50-52
- └ Spray Booth 53
- └ Dust Extraction 54-56
- └ Plastic Repair 57
- └ Dent Puller 58-61
- └ Spot Welder & MIG's 62-63
- └ Infrared & UVA LED Paint Curing Systems 64-67
- └ Tool Cabinets & Workbenches 68-71
- └ Solvent - Recyclers 72-75
- └ Solvent - Spray Gun & Pot Cleaners 76-78
- └ Waterborne - Recyclers Waterborne - Spray Gun & Pot Cleaners 78-81
- └ Matrix Wand 82
- └ Wheel Aligner 83
- └ Bumper Sensor Kits 84-85
- └ Andreae 86
- └ Bossauto 87-88
- └ Etalon 89-91
- └ Fy-Tech 92-94
- └ Induction 95
- └ Meguro 96
- └ MWM 97
- └ Planit 98-101
- └ Stucchi 102
- └ Uniram 103-104



Foam Polishing Ball

SKU: ETFBALL100



Hard Blue Polishing Pad

SKU: ET1505002



High Tack Rag

SKU: ETT641



Microfiber Cloth

SKU: ETMICRO01



Microfiber Cloth 2in1

SKU: ETMICRO02



Soft Black Profiled Polishing Pad

SKU: ET1502505



Super Soft Black Polishing Pad

Grey SKU: ET1505004



White Diamond Polishing Pad

SKU: ET1502500



Wool Polishing Ball

SKU: ETWBALL76

X-LARGE PAINTERS OVERALL  
SKU: ETOVR04



Orange Universal Polishing Pads (Large or Small)  
150 x 50mm SKU: ET1505003  
76 x 25mm SKU: ET1505003



## FY-Tech



Specializing in manufacturing automobile repair equipment with over 30 years experience in the industry.

Recently, FY-TECH has been awarded the “Zhuhai Science and Technology Enterprise” and “Zhuhai Credible Enterprise” awards as well as being a trustee of the “China Automobile Maintenance Equipment Association”.

With abundant technology capabilities, advanced production and testing equipment, we have obtained the Quality Management and Quality Assurance ISO9001:2000, the China Compulsory Certification CCC, and the European Union CE Certification and Exterior Design Patent.

Our products are strictly designed in accordance with international IEC and National GB Standards. Our products are also used and recommended by the 4S body shops of 23 well known automobile manufacturers including Volkswagen and Mazda.

We rely on outstanding product quality, advanced technology, excellent after sales service and professional management.

Based on a development policy of innovation, progressiveness and professionalism, FY-Tech is fully devoted to the automobile maintenance equipment industry. The “FY-TECH” international brand is synonymous with our principle of a lifetime of use.



**ALL IN ONE 10HP COMPRESSOR**  
SKU: FY-10HP-3IN1



**AIR COMPRESSOR 15hp**  
SKU: FY-15P



**AIR COMPRESSOR 10hp**  
SKU: FY-10P



**AIR DRYER 10hp & 15hp**  
SKU: FY-10P-DRYER  
SKU: FY-15P-DRYER



**Workbench**  
SKU: FY-800VS



**Workbench with Pegboard**  
SKU: FY-800ESH



**Workbench with Pegboard and Draws**  
SKU: FY-824SH

- └ Abrasives & Cleaning 2 - 5
- └ Polishing 6 -10
- └ Air Tools 11-15
- └ Compressors & Dryers 16-17
- └ Power Tools 18-25
- └ Hand Tools & Dollys 26-30
- └ Pulling Clamps 31-33
- └ Car Lifts & Dollys 34-37
- └ Panel Stands & Parts Racks 38-41
- └ Floor Rack 42-44
- └ Tapes & Masking 45-47
- └ Mixing Cups & Liners 48-49
- └ Filters 50-52
- └ Spray Booth 53
- └ Dust Extraction 54-56
- └ Plastic Repair 57
- └ Dent Puller 58-61
- └ Spot Welder & MIG's 62-63
- └ Infrared & UVA LED Paint Curing Systems 64-67
- └ Tool Cabinets & Workbenches 68-71
- └ Solvent - Recyclers 72-75
- └ Solvent - Spray Gun & Pot Cleaners 76-78
- └ Waterborne - Recyclers, Waterborne - Spray Gun & Pot Cleaners 78-81
- └ Matrix Wand 82
- └ Wheel Aligner 83
- └ Bumper Sensor Kits 84-85
- └ Andreae 86
- └ Bossauto 87-88
- └ Etalon 89-91
- └ **Fy-Tech** 92-94
- └ Induction 95
- └ Meguro 96
- └ MWM 97
- └ Planit 98-101
- └ Stucchi 102
- └ Uniram 103-104



**Modular Tool Station Work Benches**  
Full details on page 69



**Handheld Infrared Curing Lamp**  
SKU: FY-1000WS



**Infrared S/WAVE 2 BAR**  
SKU: FY-2W



**Infrared S/WAVE 2BAR LOW REACH**  
SKU: FY-2H



**Infrared 2AT Shortwave High Reach 2 Bar**  
SKU: FY-2AT



**Infrared 3W Short Wave 3 Bar**  
SKU: FY-3W



**Blind Rivet Gun**  
SKU: FY-KRS-505



**Paintless Dent Removal**  
FYHI-1100W  
SKU: FYHI-1100W



**Plastic Welder FY-2012S**  
SKU: FY-2012S



**Waxing Machine**  
SKU: FYZQ1801



## FY-Tech

- └ Abrasives & Cleaning 2 - 5
- └ Polishing 6 -10
- └ Air Tools 11-15
- └ Compressors & Dryers 16-17
- └ Power Tools 18-25
- └ Hand Tools & Dollys 26-30
- └ Pulling Clamps 31-33
- └ Car Lifts & Dollys 34-37
- └ Panel Stands & Parts Racks 38-41
- └ Floor Rack 42-44
- └ Tapes & Masking 45-47
- └ Mixing Cups & Liners 48-49
- └ Filters 50-52
- └ Spray Booth 53
- └ Dust Extraction 54-56
- └ Plastic Repair 57
- └ Dent Puller 58-61
- └ Spot Welder & MIG's 62-63
- └ Infrared & UVA LED Paint Curing Systems 64-67
- └ Tool Cabinets & Workbenches 68-71
- └ Solvent - Recyclers 72-75
- └ Solvent - Spray Gun & Pot Cleaners 76-78
- └ Waterborne - Recyclers Waterborne - Spray Gun & Pot Cleaners 78-81
- └ Matrix Wand 82
- └ Wheel Aligner 83
- └ Bumper Sensor Kits 84-85
- └ Andreae 86
- └ Bossauto 87-88
- └ Etalon 89-91
- └ **Fy-Tech** 92-94
- └ Induction 95
- └ Meguro 96
- └ MWM 97
- └ Planit 98-101
- └ Stucchi 102
- └ Uniram 103-104





## FY-Tech

- └ Abrasives & Cleaning 2 - 5
- └ Polishing 6 -10
- └ Air Tools 11-15
- └ Compressors & Dryers 16-17
- └ Power Tools 18-25
- └ Hand Tools & Dollies 26-30
- └ Pulling Clamps 31-33
- └ Car Lifts & Dollies 34-37
- └ Panel Stands & Parts Racks 38-41
- └ Floor Rack 42-44
- └ Tapes & Masking 45-47
- └ Mixing Cups & Liners 48-49
- └ Filters 50-52
- └ Spray Booth 53
- └ Dust Extraction 54-56
- └ Plastic Repair 57
- └ Dent Puller 58-61
- └ Spot Welder & MIG's 62-63
- └ Infrared & UVA LED Paint Curing Systems 64-67
- └ Tool Cabinets & Workbenches 68-71
- └ Solvent - Recyclers 72-75
- └ Solvent - Spray Gun & Pot Cleaners 76-78
- └ Waterborne - Recyclers, Waterborne - Spray Gun & Pot Cleaners 78-81
- └ Matrix Wand 82
- └ Wheel Aligner 83
- └ Bumper Sensor Kits 84-85
- └ Andreae 86
- └ Bossauto 87-88
- └ Etalon 89-91
- └ **Fy-Tech 92-94**
- └ Induction 95
- └ Meguro 96
- └ MWM 97
- └ Planit 98-101
- └ Stucchi 102
- └ Uniram 103-104



**Car Body Repair System**  
FY-9018  
SKU: FY-9018



**Dent Puller Complete**  
FY-91G  
SKU: FY-91G



**Inverter Spot Welder**  
16DC  
SKU: 16DC



**Multifunctional Aluminum Dent Pulling Machine**  
FY-65L  
SKU: FY-65L



**Portable IGBT Inverter MIG Welder**  
MIG Welder  
FYMIG180  
SKU: FYMIG180



**Quick Puller**  
FYF051  
SKU: FYF051



**Dent Pulling Spot Hammer**  
FYF003  
SKU: FYF003



**10mm Welding Washer 100pcs**  
FYF017A  
SKU: FYF017A



**6mm Stud 50pcs**  
FYF016  
SKU: FYF016



**OT WASHER (20 per pack)**  
FYF030  
SKU: FYF030



**Star Triangle Washer**  
FYF015  
SKU: FYF015



**Wavy Wire 50pcs Wiggle Wire**  
FYF006  
SKU: FYF006



## Induction Innovations



**Mini-Ductor II**  
IIMD800P  
SKU: IIMD800P



**Mini Ductor Venom**  
IIMDV-888  
SKU: IIMDV-888



**Inductor Pro-Max with cart.**  
IIPM-200FL  
SKU: IIPM-200FL



**Inductor Rosebud Attachment**  
IIU-511  
SKU: IIU-511



**Inductor Lite Kit with Cart**  
IIIL2000C  
SKU: IIIL2000C



**Inductor Lite Glass Blaster**  
IIIL-311  
SKU: IIIL-311



**Inductor Lite PDR Baton**  
IIIL-111  
SKU: IIIL-111



**Mini-Ductor Essential Coil Kit**  
IIMD99-660  
SKU: IIMD99-660



**Mini-Ductor Long Coil Kit**  
IIMD99-675  
SKU: IIMD99-675



**Standard Coil Kit**  
MD99-650-2019  
SKU: MD99-650-2019



**Variety Coil Pack**  
IIMD99-60123  
SKU: IIMD99-60123



- └ Abrasives & Cleaning 2 - 5
- └ Polishing 6 -10
- └ Air Tools 11-15
- └ Compressors & Dryers 16-17
- └ Power Tools 18-25
- └ Hand Tools & Dollies 26-30
- └ Pulling Clamps 31-33
- └ Car Lifts & Dollies 34-37
- └ Panel Stands & Parts Racks 38-41
- └ Floor Rack 42-44
- └ Tapes & Masking 45-47
- └ Mixing Cups & Liners 48-49
- └ Filters 50-52
- └ Spray Booth 53
- └ Dust Extraction 54-56
- └ Plastic Repair 57
- └ Dent Puller 58-61
- └ Spot Welder & MIG's 62-63
- └ Infrared & UVA LED Paint Curing Systems 64-67
- └ Tool Cabinets & Workbenches 68-71
- └ Solvent - Recyclers 72-75
- └ Solvent - Spray Gun & Pot Cleaners 76-78
- └ Waterborne - Recyclers Waterborne - Spray Gun & Pot Cleaners 78-81
- └ Matrix Wand 82
- └ Wheel Aligner 83
- └ Bumper Sensor Kits 84-85
- └ Andreae 86
- └ Bossauto 87-88
- └ Etalon 89-91
- └ **Fy-Tech 92-94**
- └ **Induction 95**
- └ Meguro 96
- └ MWM 97
- └ Planit 98-101
- └ Stucchi 102
- └ Uniram 103-104

## FY-Tech



Japanese company Meguro manufactures this patented seam tape used by many vehicle manufacturers on numerous vehicles.

Accurately replicating the OEM seam seal on many vehicles (not flat like other brands) and flexible enough to go around corners without cutting, Meguro seam seal tape gives an OEM result in no time. Just spray on the primer, apply the tape and it's ready to paint immediately!



Sealing Tape 16m x 10mm

SKU: MST1610



Sealing Tape 16m x 8mm

SKU: MST168



Sealing Tape 16m x 6mm

SKU: MST166



Dress Tape 9m x 10mm

SKU: MSMDT910



Dress Tape 9m x 8mm

SKU: MSMDT98



MEGURO Primer 420ml

SKU: MSTP420



MEGURO Sealing Tape Roller

SKU: MSMRST

- └ Abrasives & Cleaning 2-5
- └ Polishing 6-10
- └ Air Tools 11-15
- └ Compressors & Dryers 16-17
- └ Power Tools 18-25
- └ Hand Tools & Dollies 26-30
- └ Pulling Clamps 31-33
- └ Car Lifts & Dollies 34-37
- └ Panel Stands & Parts Racks 38-41
- └ Floor Rack 42-44
- └ Tapes & Masking 45-47
- └ Mixing Cups & Liners 48-49
- └ Filters 50-52
- └ Spray Booth 53
- └ Dust Extraction 54-56
- └ Plastic Repair 57
- └ Dent Puller 58-61
- └ Spot Welder & MIG's 62-63
- └ Infrared & UVA LED Paint Curing Systems 64-67
- └ Tool Cabinets & Workbenches 68-71
- └ Solvent - Recyclers 72-75
- └ Solvent - Spray Gun & Pot Cleaners 76-78
- └ Waterborne - Recyclers, Waterborne - Spray Gun & Pot Cleaners 78-81
- └ Matrix Wand 82
- └ Wheel Aligner 83
- └ Bumper Sensor Kits 84-85
- └ Andreae 86
- └ Bossauto 87-88
- └ Etalon 89-91
- └ FY-Tech 92-94
- └ Induction 95
- └ Meguro 96
- └ MWM 97
- └ Planit 98-101
- └ Stucchi 102
- └ Uniram 103-104

## Induction Innovations



15 Piece Drill Kit for Parking Sensors  
SKU: MWM30603



6 Piece Drill Kit for Parking Sensors  
SKU: MWM30601



24mm Drill for Parking Sensors  
SKU: MWM306240



26mm Drill Bit for Parking Sensors  
SKU: MWM306260

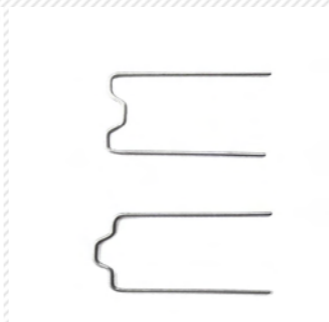

Plastic Repair Stapels  
Inverted  
SKU: MWM31069  
Straight  
SKU: MWM31068

- └ Abrasives & Cleaning 2-5
- └ Polishing 6-10
- └ Air Tools 11-15
- └ Compressors & Dryers 16-17
- └ Power Tools 18-25
- └ Hand Tools & Dollies 26-30
- └ Pulling Clamps 31-33
- └ Car Lifts & Dollies 34-37
- └ Panel Stands & Parts Racks 38-41
- └ Floor Rack 42-44
- └ Tapes & Masking 45-47
- └ Mixing Cups & Liners 48-49
- └ Filters 50-52
- └ Spray Booth 53
- └ Dust Extraction 54-56
- └ Plastic Repair 57
- └ Dent Puller 58-61
- └ Spot Welder & MIG's 62-63
- └ Infrared & UVA LED Paint Curing Systems 64-67
- └ Tool Cabinets & Workbenches 68-71
- └ Solvent - Recyclers 72-75
- └ Solvent - Spray Gun & Pot Cleaners 76-78
- └ Waterborne - Recyclers Waterborne - Spray Gun & Pot Cleaners 78-81
- └ Matrix Wand 82
- └ Wheel Aligner 83
- └ Bumper Sensor Kits 84-85
- └ Andreae 86
- └ Bossauto 87-88
- └ Etalon 89-91
- └ FY-Tech 92-94
- └ Induction 95
- └ Meguro 96
- └ MWM 97
- └ Planit 98-101
- └ Stucchi 102
- └ Uniram 103-104



## PLANiT



# PLANiT®

solutions for the future

- └ Abrasives & Cleaning 2 - 5
- └ Polishing 6 -10
- └ Air Tools 11-15
- └ Compressors & Dryers 16-17
- └ Power Tools 18-25
- └ Hand Tools & Dollys 26-30
- └ Pulling Clamps 31-33
- └ Car Lifts & Dollys 34-37
- └ Panel Stands & Parts Racks 38-41
- └ Floor Rack 42-44
- └ Tapes & Masking 45-47
- └ Mixing Cups & Liners 48-49
- └ Filters 50-52
- └ Spray Booth 53
- └ Dust Extraction 54-56
- └ Plastic Repair 57
- └ Dent Puller 58-61
- └ Spot Welder & MIG's 62-63
- └ Infrared & UVA LED Paint Curing Systems 64-67
- └ Tool Cabinets & Workbenches 68-71
- └ Solvent - Recyclers 72-75
- └ Solvent - Spray Gun & Pot Cleaners 76-78
- └ Waterborne - Recyclers, Waterborne - Spray Gun & Pot Cleaners 78-81
- └ Matrix Wand 82
- └ Wheel Aligner 83
- └ Bumper Sensor Kits 84-85
- └ Andreae 86
- └ Bossauto 87-88
- └ Etalon 89-91
- └ Fy-Tech 92-94
- └ Induction 95
- └ Meguro 96
- └ MWM 97
- └ Planit 98-101
- └ Stucchi 102
- └ Uniram 103-104



Clean Air Flow Ceiling Filters 560 Grade



Clean Air Flow Ceiling Filters 660 Grade



PlanIT Pre Filter

1.2m x 23m 565G SKU: PI0023  
 1.6m x 13m 565G SKU: PI0024  
 2.0m x 20m 565G SKU: PI0025  
 Rolls can be cut into Pads at a Per Meter Charge.

1.0m x 20m 665G SKU: PI0012  
 1.2m x 23m 665G SKU: PI0013  
 1.5m x 16m 665G SKU: PI0010  
 1.6m x 13m 665G SKU: PI0014  
 2.0m x 20m 665G SKU: PI0011  
 Rolls can be cut into Pads at a Per Meter Charge.

1m x 32m SKU: PI0021  
 2m x 20m SKU: PI0018

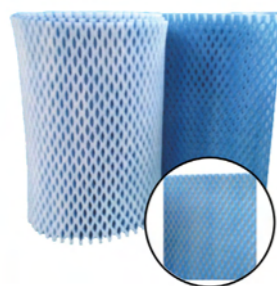

Pocket Exhaust Filter 75cm x 22m SKU: PI0022



190um Solvent Borne Paper Cone Filters SKU: PI-0003-190 (Sleeves of 250) (Carton of 1000)



125um Water Borne Paper Cone Filters SKU: PI-0003-125 (Sleeves of 250) (Carton of 1000)



PLAN-IT Plastic 4.8M X 100M SKU: PIMF48100



Cover Mask Refills 1800 x 33M SKU: PIMR180033



Cover Mask Complete 1800 x 33M SKU: PIMC180033



## PLANiT



PLANIT 190um Lid & Liners For Solvent Base. 50pack 400ml SKU: PIT400190 600ml SKU: PIT600190 800ml SKU: PIT800190

PLANIT 125um Lid & Liners For Water Base. 50pack 600ml SKU: PIT600125 800ml SKU: PIT800125

PLANIT Cup & Collar 2pack Large Size SKU: 8003 Medium Size SKU: 8002 Small Size SKU: 8007



GTI ADAPTOR SKU: PIT08020



IWATA ADAPTOR SKU: PIT08021



SATA ADAPTOR SKU: PIT08022



SATA QUICK RELEASE ADAPTOR SKU: PIT08023

GTI Adaptor SKU: PIT08020

IWATA Adaptor SKU: PIT08021

SATA Adaptor SKU: PIT08022

SATA Quick Release Adaptor SKU: PIT08023



2240ml SKU: PI-MC2240



2240ml SKU: PI-MC2240



2240ml SKU: PI-MC2240



2240ml SKU: PI-MC2240

PLANIT Mixing Cups - 200pcs



PlanIT Fiberglass Exhaust Filter - 20m Rolls (500cm x 20m) SKU: PI0001 (750cm x 20m) SKU: PI0004



Water Borne Filter 75cm x 20m SKU: PI0030

PLANIT Mixing Cups - 200pcs 2240ml (1000cm x 20m) SKU: PI0006 (1500cm x 20m) SKU: PI0008 (2000cm x 20m) SKU: PI0009

- └ Abrasives & Cleaning 2 - 5
- └ Polishing 6 -10
- └ Air Tools 11-15
- └ Compressors & Dryers 16-17
- └ Power Tools 18-25
- └ Hand Tools & Dollys 26-30
- └ Pulling Clamps 31-33
- └ Car Lifts & Dollys 34-37
- └ Panel Stands & Parts Racks 38-41
- └ Floor Rack 42-44
- └ Tapes & Masking 45-47
- └ Mixing Cups & Liners 48-49
- └ Filters 50-52
- └ Spray Booth 53
- └ Dust Extraction 54-56
- └ Plastic Repair 57
- └ Dent Puller 58-61
- └ Spot Welder & MIG's 62-63
- └ Infrared & UVA LED Paint Curing Systems 64-67
- └ Tool Cabinets & Workbenches 68-71
- └ Solvent - Recyclers 72-75
- └ Solvent - Spray Gun & Pot Cleaners 76-78
- └ Waterborne - Recyclers Waterborne - Spray Gun & Pot Cleaners 78-81
- └ Matrix Wand 82
- └ Wheel Aligner 83
- └ Bumper Sensor Kits 84-85
- └ Andreae 86
- └ Bossauto 87-88
- └ Etalon 89-91
- └ Fy-Tech 92-94
- └ Induction 95
- └ Meguro 96
- └ MWM 97
- └ Planit 98-101
- └ Stucchi 102
- └ Uniram 103-104



## PLANiT

- └ Abrasives & Cleaning 2-5
- └ Polishing 6-10
- └ Air Tools 11-15
- └ Compressors & Dryers 16-17
- └ Power Tools 18-25
- └ Hand Tools & Dollies 26-30
- └ Pulling Clamps 31-33
- └ Car Lifts & Dollies 34-37
- └ Panel Stands & Parts Racks 38-41
- └ Floor Rack 42-44
- └ Tapes & Masking 45-47
- └ Mixing Cups & Liners 48-49
- └ Filters 50-52
- └ Spray Booth 53
- └ Dust Extraction 54-56
- └ Plastic Repair 57
- └ Dent Puller 58-61
- └ Spot Welder & MIG's 62-63
- └ Infrared & UVA LED Paint Curing Systems 64-67
- └ Tool Cabinets & Workbenches 68-71
- └ Solvent - Recyclers 72-75
- └ Solvent - Spray Gun & Pot Cleaners 76-78
- └ Waterborne - Recyclers, Waterborne - Spray Gun & Pot Cleaners 78-81
- └ Matrix Wand 82
- └ Wheel Aligner 83
- └ Bumper Sensor Kits 84-85
- └ Andreae 86
- └ Bossauto 87-88
- └ Etalon 89-91
- └ Fy-Tech 92-94
- └ Induction 95
- └ Meguro 96
- └ MWM 97
- └ Planit 98-101
- └ Stucchi 102
- └ Uniram 103-104



**150mm Backing Plate for Dual Action Polisher**  
SKU: PI-TDAB/BACKINGPLATE



**3 inch Air Angle Sander and Polisher**  
SKU: PICO128-047



**3 inch Air Palm Sander / Denibber**  
SKU: PICO128-048



**6 inch Air Orbital Sander 2.5mm**  
SKU: PICO128-044



**6 inch Air Palm Sander 5.0mm**  
SKU: PICO128-045



**Air Drill Reversible 3/8 inch**  
SKU: PICO128-051



**Air Ratchet Mini Wrench**  
SKU: PICO128-053



**Mini Air Die Grinder and Eraser Stripping Tool**  
SKU: PICO128-052



**Mini Disc Air Sander Kit with 4pcs**  
SKU: PICO128-049



**Palm Sander Electric**  
SKU: PI-TW-AJ46



**Heat Gun**  
SKU: PI-THGS 1



**Dual Action Polisher**  
SKU: PI-TDAB



## PLANiT

- └ Abrasives & Cleaning 2-5
- └ Polishing 6-10
- └ Air Tools 11-15
- └ Compressors & Dryers 16-17
- └ Power Tools 18-25
- └ Hand Tools & Dollies 26-30
- └ Pulling Clamps 31-33
- └ Car Lifts & Dollies 34-37
- └ Panel Stands & Parts Racks 38-41
- └ Floor Rack 42-44
- └ Tapes & Masking 45-47
- └ Mixing Cups & Liners 48-49
- └ Filters 50-52
- └ Spray Booth 53
- └ Dust Extraction 54-56
- └ Plastic Repair 57
- └ Dent Puller 58-61
- └ Spot Welder & MIG's 62-63
- └ Infrared & UVA LED Paint Curing Systems 64-67
- └ Tool Cabinets & Workbenches 68-71
- └ Solvent - Recyclers 72-75
- └ Solvent - Spray Gun & Pot Cleaners 76-78
- └ Waterborne - Recyclers, Waterborne - Spray Gun & Pot Cleaners 78-81
- └ Matrix Wand 82
- └ Wheel Aligner 83
- └ Bumper Sensor Kits 84-85
- └ Andreae 86
- └ Bossauto 87-88
- └ Etalon 89-91
- └ Fy-Tech 92-94
- └ Induction 95
- └ Meguro 96
- └ MWM 97
- └ Planit 98-101
- └ Stucchi 102
- └ Uniram 103-104



**Planit Rotary Polishing Buff**  
SKU: PI-SRBV



**Blow Gun Kit 7 Piece**  
SKU: PICO128-050



**Colour Matching Light & PEN in a Case**  
SKU: PI32036-1



**5 in 1 Seat Cover Set**  
SKU: PI-5 in1KIT



**Hot Stapler Plastic Repair Kit**  
SKU: PIHSPRK



**Onion Board**  
SKU: PLOB



**Paint Pot 5 Litre**  
SKU: PI5LTB



**PDR Line Board**  
SKU: PILBL



**Tack RAG Large RFU Water Borne**  
SKU: PI1503ECO



**Vacuum Sanding Kit**  
SKU: PISBK5PC



**Velcro Sanding Block Set Kit - 6 Piece**  
SKU: PI031-069



**Panel Beating Hammer Dolly**  
SKU: PI071-006



Stucchi

- └ Abrasives & Cleaning 2-5
- └ Polishing 6-10
- └ Air Tools 11-15
- └ Compressors & Dryers 16-17
- └ Power Tools 18-25
- └ Hand Tools & Dollies 26-30
- └ Pulling Clamps 31-33
- └ Car Lifts & Dollies 34-37
- └ Panel Stands & Parts Racks 38-41
- └ Floor Rack 42-44
- └ Tapes & Masking 45-47
- └ Mixing Cups & Liners 48-49
- └ Filters 50-52
- └ Spray Booth 53
- └ Dust Extraction 54-56
- └ Plastic Repair 57
- └ Dent Puller 58-61
- └ Spot Welder & MIG's 62-63
- └ Infrared & UVA LED Paint Curing Systems 64-67
- └ Tool Cabinets & Workbenches 68-71
- └ Solvent - Recyclers 72-75
- └ Solvent - Spray Gun & Pot Cleaners 76-78
- └ Waterborne - Recyclers, Waterborne - Spray Gun & Pot Cleaners 78-81
- └ Matrix Wand 82
- └ Wheel Aligner 83
- └ Bumper Sensor Kits 84-85
- └ Andreae 86
- └ Bossauto 87-88
- └ Etalon 89-91
- └ Fy-Tech 92-94
- └ Induction 95
- └ Meguro 96
- └ MWM 97
- └ Planit 98-101
- └ Stucchi 102
- └ Uniram 103-104



Dust Exhauster ST1-C  
SKU: ST1-C



Dust Exhauster ST2-C  
SKU: ST2-C



Dust Exhauster ST2-COMBI  
SKU: ST2-Combi



Dust Exhauster M1-JOLLY  
SKU: M1-JOLLY



KIT PC-1  
SKU: KIT PC-1



Articulated Arm B5  
SKU: B5



Dust Exhauster ME-1  
SKU: ME-1



Dust Exhauster ME-1P  
SKU: ME-1P



Dust Exhauster ST1-M  
SKU: ST1-M



UNIRAM



Uni-ram Automotive manufactures environmentally friendly equipment for collision repair shops. Equipment includes spray gun cleaners, recyclers for solvents and water cleaners.



URS400TSN  
Mini Solvent Recycler  
SKU: URS400TSN



URS600 - Solvent Recycler  
Economy (20L)  
SKU: UNIS600



URS600EP2 - URS600 with  
Auto Transfer  
SKU: UNIS600EP2



URS900 - 20L  
Solvent Recycler  
UNIS900



URS900EP2 - URS900 with  
Auto Transfer  
SKU: UNIS900EP2



COMBO656 - Recycler/Gun-  
wash/600 & UG6000  
SKU: UNICOMBO656-CE



URS2000SS - 80litre Tank  
SKU: UNIS2000SS



UG110 - Gun Cleaner Auto  
SKU: UNIUG110



Wall Mount  
UM80S - Gun Cleaner Solvent  
SKU: UNIU80S

- 2-5 Abrasives & Cleaning
- 6-10 Polishing
- 11-15 Air Tools
- 16-17 Compressors & Dryers
- 18-25 Power Tools
- 26-30 Hand Tools & Dollies
- 31-33 Pulling Clamps
- 34-37 Car Lifts & Dollies
- 38-41 Panel Stands & Parts Racks
- 42-44 Floor Rack
- 45-47 Tapes & Masking
- 48-49 Mixing Cups & Liners
- 50-52 Filters
- 53 Spray Booth
- 54-56 Dust Extraction
- 57 Plastic Repair
- 58-61 Dent Puller
- 62-63 Spot Welder & MIG's
- 64-67 Infrared & UVA LED Paint Curing Systems
- 68-71 Tool Cabinets & Workbenches
- 72-75 Solvent - Recyclers
- 76-78 Solvent - Spray Gun & Pot Cleaners
- 78-81 Waterborne - Recyclers Waterborne - Spray Gun & Pot Cleaners
- 82 Matrix Wand
- 83 Wheel Aligner
- 84-85 Bumper Sensor Kits
- 86 Andreae
- 87-88 Bossauto
- 89-91 Etalon
- 92-94 Fy-Tech
- 95 Induction
- 96 Meguro
- 97 MWM
- 98-101 Planit
- 102 Stucchi
- 103-104 Uniram



UNIRAM

- └ Abrasives & Cleaning 2-5
- └ Polishing 6-10
- └ Air Tools 11-15
- └ Compressors & Dryers 16-17
- └ Power Tools 18-25
- └ Hand Tools & Dollies 26-30
- └ Pulling Clamps 31-33
- └ Car Lifts & Dollies 34-37
- └ Panel Stands & Parts Racks 38-41
- └ Floor Rack 42-44
- └ Tapes & Masking 45-47
- └ Mixing Cups & Liners 48-49
- └ Filters 50-52
- └ Spray Booth 53
- └ Dust Extraction 54-56
- └ Plastic Repair 57
- └ Dent Puller 58-61
- └ Spot Welder & MIG's 62-63
- └ Infrared & UVA LED Paint Curing Systems 64-67
- └ Tool Cabinets & Workbenches 68-71
- └ Solvent - Recyclers 72-75
- └ Solvent - Spray Gun & Pot Cleaners 76-78
- └ Waterborne - Recyclers, Waterborne - Spray Gun & Pot Cleaners 78-81
- └ Matrix Wand 82
- └ Wheel Aligner 83
- └ Bumper Sensor Kits 84-85
- └ Andreae 86
- └ Bossauto 87-88
- └ Etalon 89-91
- └ Fy-Tech 92-94
- └ Induction 95
- └ Meguro 96
- └ MWM 97
- └ Planit 98-101
- └ Stucchi 102
- └ Uniram 103-104

- 2-5 Abrasives & Cleaning
- 6-10 Polishing
- 11-15 Air Tools
- 16-17 Compressors & Dryers
- 18-25 Power Tools
- 26-30 Hand Tools & Dollies
- 31-33 Pulling Clamps
- 34-37 Car Lifts & Dollies
- 38-41 Panel Stands & Parts Racks
- 42-44 Floor Rack
- 45-47 Tapes & Masking
- 48-49 Mixing Cups & Liners
- 50-52 Filters
- 53 Spray Booth
- 54-56 Dust Extraction
- 57 Plastic Repair
- 58-61 Dent Puller
- 62-63 Spot Welder & MIG's
- 64-67 Infrared & UVA LED Paint Curing Systems
- 68-71 Tool Cabinets & Workbenches
- 72-75 Solvent - Recyclers
- 76-78 Solvent - Spray Gun & Pot Cleaners
- 78-81 Waterborne - Recyclers Waterborne - Spray Gun & Pot Cleaners
- 82 Matrix Wand
- 83 Wheel Aligner
- 84-85 Bumper Sensor Kits
- 86 Andreae
- 87-88 Bossauto
- 89-91 Etalon
- 92-94 Fy-Tech
- 95 Induction
- 96 Meguro
- 97 MWM
- 98-101 Planit
- 102 Stucchi
- 103-104 Uniram



UG2000D - Two Gun Cleaner SKU: UNIUG2000D  
 UG4000D - Two Gun Cleaner with Vent SKU: UNIUG4000D  
 UG7500E - 2 Gun SKU: UNIUG7500E



UG5000W - Gun Cleaner Water and Solvent SKU: UNIUG5000W  
 AQUA KLEEN SKU: UNI102-820  
 COAG KLEEN 2KG SKU: UNI102-8300



UM120W - Gun Cleaner Water Base SKU: UNIU120W  
 UM80W - Gun Cleaner Water Base Manual SKU: UNIU80W  
 UM80WF - Gun Cleaner Water Base Wall Mount SKU: UNIU80WF

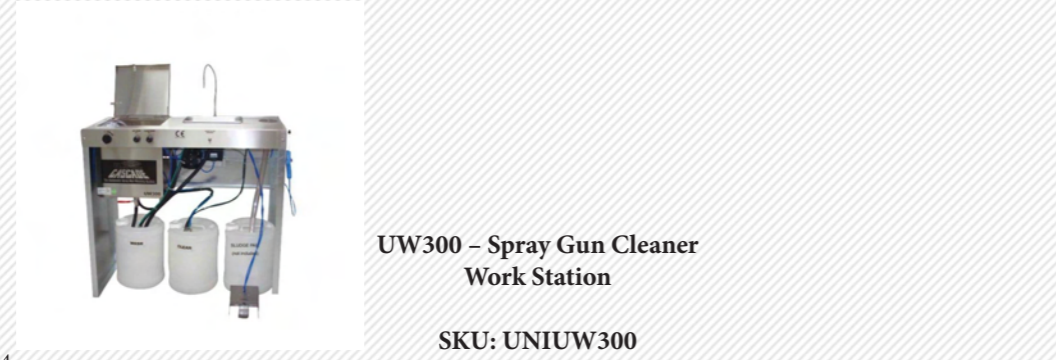

UW300 - Spray Gun Cleaner Work Station  
 SKU: UNIUW300

